





Assembly code	Assembly description	Assembly image
ASM2853B/0.D02	Cooking chamber	
ASM2854A/0.D01	External cover	
ASM4081A/0.D00	Door	
ASM4102A/0.D02	General overview	

ASM2853B/0.D02 - Cooking chamber - FRONT



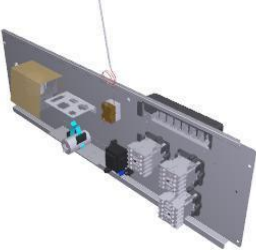
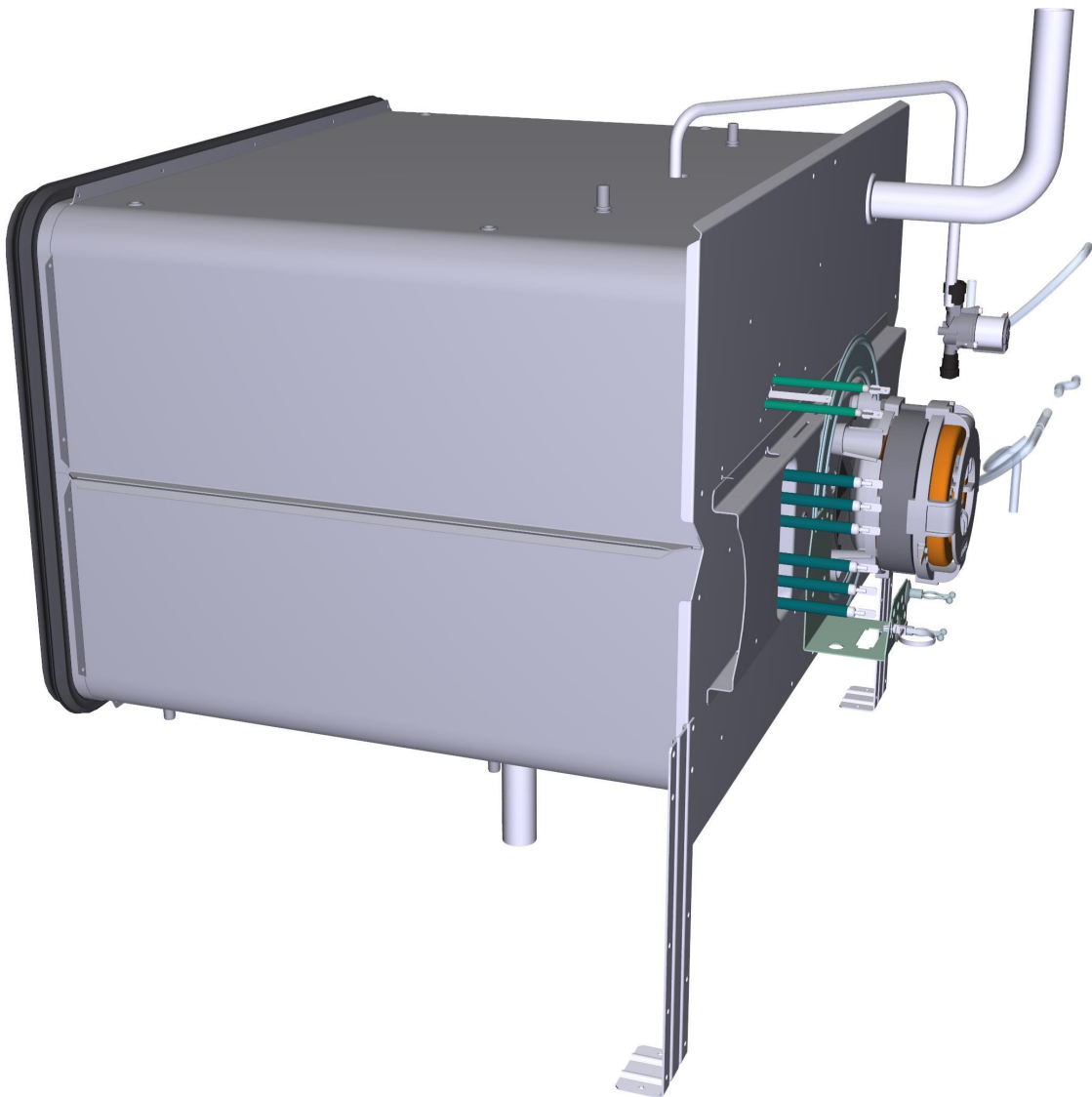



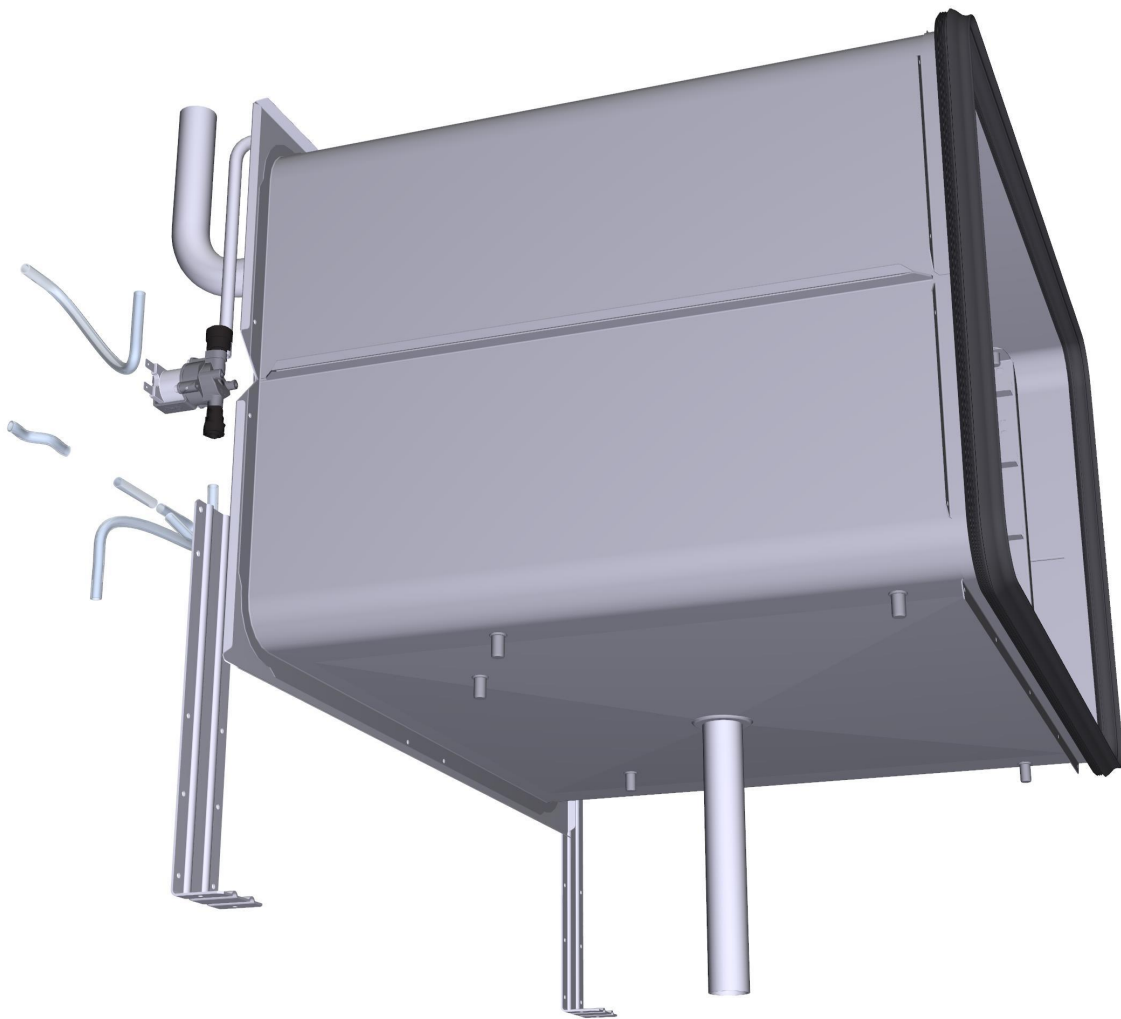





ASM2853B/0.D02 - Cooking chamber - REAR







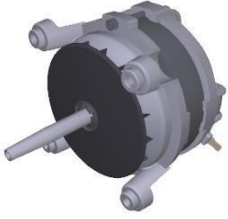

COMPONENT			SPARE PART										
Code	Description	Image	Code	Description	Kit components								
0G1490A	XVC305E XV393 FAN GUARD		0G1490A0	XVC305E XV393 FAN GUARD									
0G1493A	XVC305E/705E FAN GUARD SPACER		0G1493A0	XVC305E/705E FAN GUARD SPACER									
0H2551A	ST STEEL DRAIN GRID		K0H2551A	DRAIN COVER KIT	<table border="1"> <thead> <tr> <th>Code</th> <th>Description</th> <th>Qty</th> <th>UOM</th> </tr> </thead> <tbody> <tr> <td>0H2617A0</td> <td>AISI316 DRAIN GRID</td> <td>1.000</td> <td>PC</td> </tr> </tbody> </table>	Code	Description	Qty	UOM	0H2617A0	AISI316 DRAIN GRID	1.000	PC
Code	Description	Qty	UOM										
0H2617A0	AISI316 DRAIN GRID	1.000	PC										
0H4820A	BULB HOLDING BRACKET		0H4820A1	BULB HOLDING BRACKET									
0H6334A	BL CL COOKING CHAMBER HOLDING BRACKET		0H6334A0	BL CL COOKING CHAMBER HOLDING BRACKET									



COMPONENT			SPARE PART																						
Code	Description	Image	Code	Description	Kit components																				
0H3586A	ZINCED MOTOR GUARD PLATE XBC-XVC		0H3586A0	ZINCED MOTOR GUARD PLATE XBC-XVC																					
0H4305A	ST. STEEL MOTOR SHAFT SEALING DIS		K0H4305A	SEALING DISC FOR MOTOR SHAFT KIT	<table border="1"> <thead> <tr> <th>Code</th> <th>Description</th> <th>Qty</th> <th>UOM</th> </tr> </thead> <tbody> <tr> <td>0H8118A0</td> <td>XEVL MOTOR SHAFT DISC</td> <td>1.000</td> <td>PC</td> </tr> <tr> <td>GN1140A3</td> <td>MOLDED MOTOR HOLDER GASKET</td> <td>1.000</td> <td>PC</td> </tr> <tr> <td>SL1045A0</td> <td>S57 BLACK SILICONE - 80ml CARTRIDGE</td> <td>1.000</td> <td>PC</td> </tr> <tr> <td>VI1220A1</td> <td>4,2x12 TCB SELF-TAPPIN G SCREW</td> <td>3.000</td> <td>PC</td> </tr> </tbody> </table>	Code	Description	Qty	UOM	0H8118A0	XEVL MOTOR SHAFT DISC	1.000	PC	GN1140A3	MOLDED MOTOR HOLDER GASKET	1.000	PC	SL1045A0	S57 BLACK SILICONE - 80ml CARTRIDGE	1.000	PC	VI1220A1	4,2x12 TCB SELF-TAPPIN G SCREW	3.000	PC
Code	Description	Qty	UOM																						
0H8118A0	XEVL MOTOR SHAFT DISC	1.000	PC																						
GN1140A3	MOLDED MOTOR HOLDER GASKET	1.000	PC																						
SL1045A0	S57 BLACK SILICONE - 80ml CARTRIDGE	1.000	PC																						
VI1220A1	4,2x12 TCB SELF-TAPPIN G SCREW	3.000	PC																						
0H4851A	BT CT WIRING SUPPORT BRACKET		0H4851A1	BT CT WIRING SUPPORT BRACKET																					
GN1140A	MOLDED MOTOR HOLDER GASKET		KGN1140A	5 PCS. MOTOR HOLDER GASKET KI	<table border="1"> <thead> <tr> <th>Code</th> <th>Description</th> <th>Qty</th> <th>UOM</th> </tr> </thead> <tbody> <tr> <td>GN1140A3</td> <td>MOLDED MOTOR HOLDER GASKET</td> <td>5.000</td> <td>PC</td> </tr> </tbody> </table>	Code	Description	Qty	UOM	GN1140A3	MOLDED MOTOR HOLDER GASKET	5.000	PC												
Code	Description	Qty	UOM																						
GN1140A3	MOLDED MOTOR HOLDER GASKET	5.000	PC																						
MT1012A	330W 230V MOTOR		KVN1130A	LUX ≤08.2017/L.MISS/S.5/ 5E MOTOR KIT	<table border="1"> <thead> <tr> <th>Code</th> <th>Description</th> <th>Qty</th> <th>UOM</th> </tr> </thead> <tbody> <tr> <td>0H8118A0</td> <td>XEVL MOTOR SHAFT DISC</td> <td>1.000</td> <td>PC</td> </tr> <tr> <td>GN1140A3</td> <td>MOLDED MOTOR HOLDER GASKET</td> <td>1.000</td> <td>PC</td> </tr> </tbody> </table>	Code	Description	Qty	UOM	0H8118A0	XEVL MOTOR SHAFT DISC	1.000	PC	GN1140A3	MOLDED MOTOR HOLDER GASKET	1.000	PC								
Code	Description	Qty	UOM																						
0H8118A0	XEVL MOTOR SHAFT DISC	1.000	PC																						
GN1140A3	MOLDED MOTOR HOLDER GASKET	1.000	PC																						

COMPONENT			SPARE PART																															
Code	Description	Image	Code	Description	Kit components																													
MT1012A	330W 230V MOTOR		KVN1130A	LUX ≤08.2017/L.MISS/S.5/ 5E MOTOR KIT	<table border="1"> <thead> <tr> <th>Code</th> <th>Description</th> <th>Qty</th> <th>UOM</th> </tr> </thead> <tbody> <tr> <td>VI1034A0</td> <td>STAINLESS STEEL WASHER 8.4x16x1</td> <td>1.000</td> <td>PC</td> </tr> <tr> <td>VI1256A0</td> <td>M8 DIN 980M ST. STEEL SELF LOCKING NUT</td> <td>1.000</td> <td>PC</td> </tr> <tr> <td>VM2196A0</td> <td>MOTOR NUT FASTENING BUSHING</td> <td>1.000</td> <td>PC</td> </tr> <tr> <td>VN1130A1</td> <td>330W 230V 50/60HZ MOTO</td> <td>1.000</td> <td>PC</td> </tr> </tbody> </table>	Code	Description	Qty	UOM	VI1034A0	STAINLESS STEEL WASHER 8.4x16x1	1.000	PC	VI1256A0	M8 DIN 980M ST. STEEL SELF LOCKING NUT	1.000	PC	VM2196A0	MOTOR NUT FASTENING BUSHING	1.000	PC	VN1130A1	330W 230V 50/60HZ MOTO	1.000	PC									
			Code	Description	Qty	UOM																												
VI1034A0	STAINLESS STEEL WASHER 8.4x16x1	1.000	PC																															
VI1256A0	M8 DIN 980M ST. STEEL SELF LOCKING NUT	1.000	PC																															
VM2196A0	MOTOR NUT FASTENING BUSHING	1.000	PC																															
VN1130A1	330W 230V 50/60HZ MOTO	1.000	PC																															
KMT1012A	LUX >08.2017 / MIND.MAPS 330W MOTOR KIT	<table border="1"> <thead> <tr> <th>Code</th> <th>Description</th> <th>Qty</th> <th>UOM</th> </tr> </thead> <tbody> <tr> <td>0H2842A0</td> <td>MT1012 CENTERING JI</td> <td>1.000</td> <td>PC</td> </tr> <tr> <td>0H8118A0</td> <td>XEVL MOTOR SHAFT DISC</td> <td>1.000</td> <td>PC</td> </tr> <tr> <td>GN1140A3</td> <td>MOLDED MOTOR HOLDER GASKET</td> <td>1.000</td> <td>PC</td> </tr> <tr> <td>MT1012A0</td> <td>330W 230V MOTOR</td> <td>1.000</td> <td>PC</td> </tr> <tr> <td>VI1077A1</td> <td>SCREW M6x12 TE INOX</td> <td>1.000</td> <td>PC</td> </tr> <tr> <td>VI1521A0</td> <td>STAINLESS STEEL WASHER D=6 6592</td> <td>1.000</td> <td>PC</td> </tr> <tr> <td>VI1966A1</td> <td>M4x14 FLATHEAD SCREW</td> <td>1.000</td> <td>PC</td> </tr> </tbody> </table>	Code	Description	Qty	UOM	0H2842A0	MT1012 CENTERING JI	1.000	PC	0H8118A0	XEVL MOTOR SHAFT DISC	1.000	PC	GN1140A3	MOLDED MOTOR HOLDER GASKET	1.000	PC	MT1012A0	330W 230V MOTOR	1.000	PC	VI1077A1	SCREW M6x12 TE INOX	1.000	PC	VI1521A0	STAINLESS STEEL WASHER D=6 6592	1.000	PC	VI1966A1	M4x14 FLATHEAD SCREW	1.000	PC
Code	Description	Qty	UOM																															
0H2842A0	MT1012 CENTERING JI	1.000	PC																															
0H8118A0	XEVL MOTOR SHAFT DISC	1.000	PC																															
GN1140A3	MOLDED MOTOR HOLDER GASKET	1.000	PC																															
MT1012A0	330W 230V MOTOR	1.000	PC																															
VI1077A1	SCREW M6x12 TE INOX	1.000	PC																															
VI1521A0	STAINLESS STEEL WASHER D=6 6592	1.000	PC																															
VI1966A1	M4x14 FLATHEAD SCREW	1.000	PC																															
VN1181A	M6 NUT 39 BLADES H81 D196 FAN		KVN1181A	D196 H81 39 BLADES FAN+SCREW M6 KIT	<table border="1"> <thead> <tr> <th>Code</th> <th>Description</th> <th>Qty</th> <th>UOM</th> </tr> </thead> <tbody> <tr> <td>VI1077A1</td> <td>SCREW M6x12 TE INOX</td> <td>1.000</td> <td>PC</td> </tr> <tr> <td>VI1521A0</td> <td>STAINLESS STEEL WASHER D=6 6592</td> <td>1.000</td> <td>PC</td> </tr> <tr> <td>VN1181A0</td> <td>M6 NUT 39 BLADES H81 D196 FAN</td> <td>1.000</td> <td>PC</td> </tr> </tbody> </table>	Code	Description	Qty	UOM	VI1077A1	SCREW M6x12 TE INOX	1.000	PC	VI1521A0	STAINLESS STEEL WASHER D=6 6592	1.000	PC	VN1181A0	M6 NUT 39 BLADES H81 D196 FAN	1.000	PC													
			Code	Description	Qty	UOM																												
VI1077A1	SCREW M6x12 TE INOX	1.000	PC																															
VI1521A0	STAINLESS STEEL WASHER D=6 6592	1.000	PC																															
VN1181A0	M6 NUT 39 BLADES H81 D196 FAN	1.000	PC																															
KVN1030A	LUX ≤08.2017S.5/S.5E D196 FAN KIT	<table border="1"> <thead> <tr> <th>Code</th> <th>Description</th> <th>Qty</th> <th>UOM</th> </tr> </thead> <tbody> <tr> <td>VI1256A0</td> <td>M8 DIN 980M ST. STEEL SELF LOCKING NUT</td> <td>1.000</td> <td>PC</td> </tr> <tr> <td>VM2196A0</td> <td>MOTOR NUT FASTENING BUSHING</td> <td>1.000</td> <td>PC</td> </tr> <tr> <td>VN1030A5</td> <td>Ø196 H81 38 BLADES MOTOR FAN</td> <td>1.000</td> <td>PC</td> </tr> </tbody> </table>	Code	Description	Qty	UOM	VI1256A0	M8 DIN 980M ST. STEEL SELF LOCKING NUT	1.000	PC	VM2196A0	MOTOR NUT FASTENING BUSHING	1.000	PC	VN1030A5	Ø196 H81 38 BLADES MOTOR FAN	1.000	PC																
Code	Description	Qty	UOM																															
VI1256A0	M8 DIN 980M ST. STEEL SELF LOCKING NUT	1.000	PC																															
VM2196A0	MOTOR NUT FASTENING BUSHING	1.000	PC																															
VN1030A5	Ø196 H81 38 BLADES MOTOR FAN	1.000	PC																															



COMPONENT			SPARE PART																										
Code	Description	Image	Code	Description	Kit components																								
0H7030A	THERMOSTAT BULB INLET COVER		K0H7030A	THERMOSTAT BULB INLET COVER KIT	<table border="1"> <thead> <tr> <th>Code</th> <th>Description</th> <th>Qty</th> <th>UOM</th> </tr> </thead> <tbody> <tr> <td>0H8120A0</td> <td>XEVL BULB PASS-THROU GH COVER</td> <td>1.000</td> <td>PC</td> </tr> </tbody> </table>	Code	Description	Qty	UOM	0H8120A0	XEVL BULB PASS-THROU GH COVER	1.000	PC																
Code	Description	Qty	UOM																										
0H8120A0	XEVL BULB PASS-THROU GH COVER	1.000	PC																										
0H8120A	XEVL BULB PASS-THROUGH COVER		0H8120A0	XEVL BULB PASS-THROUGH COVER																									
GN1531A	THERMOSTAT BULB INLET SEALING		KTR1136A	318°C -0/+24 SAFETY THERMOSTAT KIT	<table border="1"> <thead> <tr> <th>Code</th> <th>Description</th> <th>Qty</th> <th>UOM</th> </tr> </thead> <tbody> <tr> <td>0H8120A0</td> <td>XEVL BULB PASS-THROU GH COVER</td> <td>1.000</td> <td>PC</td> </tr> <tr> <td>GN1531A0</td> <td>THERMOSTAT BULB INLET SEALING</td> <td>1.000</td> <td>PC</td> </tr> <tr> <td>SL1045A0</td> <td>S57 BLACK SILICONE - 80ml CARTRIDGE</td> <td>1.000</td> <td>PC</td> </tr> <tr> <td>TR1136A0</td> <td>318°C -0/+24 1 POLE SAFETY THERMOSTAT</td> <td>1.000</td> <td>PC</td> </tr> <tr> <td>VI1220A1</td> <td>4,2x12 TCB SELF-TAPPING SCREW</td> <td>3.000</td> <td>PC</td> </tr> </tbody> </table>	Code	Description	Qty	UOM	0H8120A0	XEVL BULB PASS-THROU GH COVER	1.000	PC	GN1531A0	THERMOSTAT BULB INLET SEALING	1.000	PC	SL1045A0	S57 BLACK SILICONE - 80ml CARTRIDGE	1.000	PC	TR1136A0	318°C -0/+24 1 POLE SAFETY THERMOSTAT	1.000	PC	VI1220A1	4,2x12 TCB SELF-TAPPING SCREW	3.000	PC
Code	Description	Qty	UOM																										
0H8120A0	XEVL BULB PASS-THROU GH COVER	1.000	PC																										
GN1531A0	THERMOSTAT BULB INLET SEALING	1.000	PC																										
SL1045A0	S57 BLACK SILICONE - 80ml CARTRIDGE	1.000	PC																										
TR1136A0	318°C -0/+24 1 POLE SAFETY THERMOSTAT	1.000	PC																										
VI1220A1	4,2x12 TCB SELF-TAPPING SCREW	3.000	PC																										
GRL1220A	GRL1220A2		KGRL1220A	5 TRAYS GN1/1 LATERAL SUPPORT	<table border="1"> <thead> <tr> <th>Code</th> <th>Description</th> <th>Qty</th> <th>UOM</th> </tr> </thead> <tbody> <tr> <td>0H6583A2</td> <td>0H4370A+0H4 371A FLAT SUPPORTING PROFILE</td> <td>1.000</td> <td>PC</td> </tr> <tr> <td>0H6584A2</td> <td>0H4375A+0H4 376A FLAT SUPPORTING PROFILE</td> <td>1.000</td> <td>PC</td> </tr> <tr> <td>GRL1220A2</td> <td>GRL1220A2</td> <td>1.000</td> <td>PC</td> </tr> <tr> <td>GRL1221A2</td> <td>GRL1221A2</td> <td>1.000</td> <td>PC</td> </tr> </tbody> </table>	Code	Description	Qty	UOM	0H6583A2	0H4370A+0H4 371A FLAT SUPPORTING PROFILE	1.000	PC	0H6584A2	0H4375A+0H4 376A FLAT SUPPORTING PROFILE	1.000	PC	GRL1220A2	GRL1220A2	1.000	PC	GRL1221A2	GRL1221A2	1.000	PC				
Code	Description	Qty	UOM																										
0H6583A2	0H4370A+0H4 371A FLAT SUPPORTING PROFILE	1.000	PC																										
0H6584A2	0H4375A+0H4 376A FLAT SUPPORTING PROFILE	1.000	PC																										
GRL1220A2	GRL1220A2	1.000	PC																										
GRL1221A2	GRL1221A2	1.000	PC																										





COMPONENT			SPARE PART																						
Code	Description	Image	Code	Description	Kit components																				
GRL1221A	GRL1221A2		KGRL1220A	5 TRAYS GN1/1 LATERAL SUPPORT	<table border="1"> <thead> <tr> <th>Code</th> <th>Description</th> <th>Qty</th> <th>UOM</th> </tr> </thead> <tbody> <tr> <td>0H6583A2</td> <td>0H4370A+0H4 371A FLAT SUPPORTING PROFILE</td> <td>1.000</td> <td>PC</td> </tr> <tr> <td>0H6584A2</td> <td>0H4375A+0H4 376A FLAT SUPPORTING PROFILE</td> <td>1.000</td> <td>PC</td> </tr> <tr> <td>GRL1220A2</td> <td>GRL1220A2</td> <td>1.000</td> <td>PC</td> </tr> <tr> <td>GRL1221A2</td> <td>GRL1221A2</td> <td>1.000</td> <td>PC</td> </tr> </tbody> </table>	Code	Description	Qty	UOM	0H6583A2	0H4370A+0H4 371A FLAT SUPPORTING PROFILE	1.000	PC	0H6584A2	0H4375A+0H4 376A FLAT SUPPORTING PROFILE	1.000	PC	GRL1220A2	GRL1220A2	1.000	PC	GRL1221A2	GRL1221A2	1.000	PC
					Code	Description	Qty	UOM																	
					0H6583A2	0H4370A+0H4 371A FLAT SUPPORTING PROFILE	1.000	PC																	
					0H6584A2	0H4375A+0H4 376A FLAT SUPPORTING PROFILE	1.000	PC																	
GRL1220A2	GRL1220A2	1.000	PC																						
GRL1221A2	GRL1221A2	1.000	PC																						
<table border="1"> <thead> <tr> <th>Code</th> <th>Description</th> <th>Qty</th> <th>UOM</th> </tr> </thead> <tbody> <tr> <td>EL1251A0</td> <td>1-WAY WATER SOLENOID VALVE</td> <td>1.000</td> <td>PC</td> </tr> </tbody> </table>	Code	Description	Qty	UOM	EL1251A0	1-WAY WATER SOLENOID VALVE	1.000	PC																	
Code	Description	Qty	UOM																						
EL1251A0	1-WAY WATER SOLENOID VALVE	1.000	PC																						
<table border="1"> <thead> <tr> <th>Code</th> <th>Description</th> <th>Qty</th> <th>UOM</th> </tr> </thead> <tbody> <tr> <td>GN1672A1</td> <td>BREAKING ELEMENT GASKET</td> <td>1.000</td> <td>PC</td> </tr> <tr> <td>RS1274A0</td> <td>100W 60V 1 TURN FLAT ELEMENT</td> <td>1.000</td> <td>PC</td> </tr> <tr> <td>SL1045A0</td> <td>S57 BLACK SILICONE - 80ml CARTRIDGE</td> <td>1.000</td> <td>PC</td> </tr> <tr> <td>VI1220A1</td> <td>4,2x12 TCB SELF-TAPPIN G SCREW</td> <td>2.000</td> <td>PC</td> </tr> </tbody> </table>	Code	Description	Qty	UOM	GN1672A1	BREAKING ELEMENT GASKET	1.000	PC	RS1274A0	100W 60V 1 TURN FLAT ELEMENT	1.000	PC	SL1045A0	S57 BLACK SILICONE - 80ml CARTRIDGE	1.000	PC	VI1220A1	4,2x12 TCB SELF-TAPPIN G SCREW	2.000	PC					
Code	Description	Qty	UOM																						
GN1672A1	BREAKING ELEMENT GASKET	1.000	PC																						
RS1274A0	100W 60V 1 TURN FLAT ELEMENT	1.000	PC																						
SL1045A0	S57 BLACK SILICONE - 80ml CARTRIDGE	1.000	PC																						
VI1220A1	4,2x12 TCB SELF-TAPPIN G SCREW	2.000	PC																						
<table border="1"> <thead> <tr> <th>Code</th> <th>Description</th> <th>Qty</th> <th>UOM</th> </tr> </thead> <tbody> <tr> <td>GN1326A1</td> <td>ELEMENT SEALING</td> <td>1.000</td> <td>PC</td> </tr> <tr> <td>RS1261A0</td> <td>BAKERLUXCH EFLUX MOTOR BRAKING ELEMENT</td> <td>1.000</td> <td>PC</td> </tr> <tr> <td>SL1045A0</td> <td>S57 BLACK SILICONE - 80ml CARTRIDGE</td> <td>1.000</td> <td>PC</td> </tr> <tr> <td>VI1220A1</td> <td>4,2x12 TCB SELF-TAPPIN G SCREW</td> <td>2.000</td> <td>PC</td> </tr> </tbody> </table>	Code	Description	Qty	UOM	GN1326A1	ELEMENT SEALING	1.000	PC	RS1261A0	BAKERLUXCH EFLUX MOTOR BRAKING ELEMENT	1.000	PC	SL1045A0	S57 BLACK SILICONE - 80ml CARTRIDGE	1.000	PC	VI1220A1	4,2x12 TCB SELF-TAPPIN G SCREW	2.000	PC					
Code	Description	Qty	UOM																						
GN1326A1	ELEMENT SEALING	1.000	PC																						
RS1261A0	BAKERLUXCH EFLUX MOTOR BRAKING ELEMENT	1.000	PC																						
SL1045A0	S57 BLACK SILICONE - 80ml CARTRIDGE	1.000	PC																						
VI1220A1	4,2x12 TCB SELF-TAPPIN G SCREW	2.000	PC																						



COMPONENT			SPARE PART																						
Code	Description	Image	Code	Description	Kit components																				
GN1326A	ELEMENT SEALING		KRS1215A	147W MOTOR BRAKING ELEMENT KIT	<table border="1"> <thead> <tr> <th>Code</th> <th>Description</th> <th>Qty</th> <th>UOM</th> </tr> </thead> <tbody> <tr> <td>GN1672A1</td> <td>BREAKING ELEMENT GASKET</td> <td>1.000</td> <td>PC</td> </tr> <tr> <td>RS1215A1</td> <td>147W 105V BRAKING ELEMENT</td> <td>1.000</td> <td>PC</td> </tr> <tr> <td>SL1045A0</td> <td>S57 BLACK SILICONE - 80ml CARTRIDGE</td> <td>1.000</td> <td>PC</td> </tr> <tr> <td>VI1220A1</td> <td>4,2x12 TCB SELF-TAPPIN G SCREW</td> <td>2.000</td> <td>PC</td> </tr> </tbody> </table>	Code	Description	Qty	UOM	GN1672A1	BREAKING ELEMENT GASKET	1.000	PC	RS1215A1	147W 105V BRAKING ELEMENT	1.000	PC	SL1045A0	S57 BLACK SILICONE - 80ml CARTRIDGE	1.000	PC	VI1220A1	4,2x12 TCB SELF-TAPPIN G SCREW	2.000	PC
			Code	Description	Qty	UOM																			
			GN1672A1	BREAKING ELEMENT GASKET	1.000	PC																			
			RS1215A1	147W 105V BRAKING ELEMENT	1.000	PC																			
			SL1045A0	S57 BLACK SILICONE - 80ml CARTRIDGE	1.000	PC																			
			VI1220A1	4,2x12 TCB SELF-TAPPIN G SCREW	2.000	PC																			
			KRS1095A	1.2kW HEATING ELEMENT KIT	<table border="1"> <thead> <tr> <th>Code</th> <th>Description</th> <th>Qty</th> <th>UOM</th> </tr> </thead> <tbody> <tr> <td>GN1326A1</td> <td>ELEMENT SEALING</td> <td>1.000</td> <td>PC</td> </tr> <tr> <td>RS1095A1</td> <td>HEATING ELEMENT 1200W 230V</td> <td>1.000</td> <td>PC</td> </tr> <tr> <td>SL1045A0</td> <td>S57 BLACK SILICONE - 80ml CARTRIDGE</td> <td>1.000</td> <td>PC</td> </tr> <tr> <td>VI1220A1</td> <td>4,2x12 TCB SELF-TAPPIN G SCREW</td> <td>2.000</td> <td>PC</td> </tr> </tbody> </table>	Code	Description	Qty	UOM	GN1326A1	ELEMENT SEALING	1.000	PC	RS1095A1	HEATING ELEMENT 1200W 230V	1.000	PC	SL1045A0	S57 BLACK SILICONE - 80ml CARTRIDGE	1.000	PC	VI1220A1	4,2x12 TCB SELF-TAPPIN G SCREW	2.000	PC
			Code	Description	Qty	UOM																			
			GN1326A1	ELEMENT SEALING	1.000	PC																			
			RS1095A1	HEATING ELEMENT 1200W 230V	1.000	PC																			
			SL1045A0	S57 BLACK SILICONE - 80ml CARTRIDGE	1.000	PC																			
			VI1220A1	4,2x12 TCB SELF-TAPPIN G SCREW	2.000	PC																			
KRS1012A	1365W 120V HEATING ELEMENT KIT	<table border="1"> <thead> <tr> <th>Code</th> <th>Description</th> <th>Qty</th> <th>UOM</th> </tr> </thead> <tbody> <tr> <td>GN1326A1</td> <td>ELEMENT SEALING</td> <td>1.000</td> <td>PC</td> </tr> <tr> <td>RS1012A0</td> <td>CIRCULAR ELEMENT 1365W 120V</td> <td>1.000</td> <td>PC</td> </tr> <tr> <td>VI1220A1</td> <td>4,2x12 TCB SELF-TAPPIN G SCREW</td> <td>5.000</td> <td>PC</td> </tr> </tbody> </table>	Code	Description	Qty	UOM	GN1326A1	ELEMENT SEALING	1.000	PC	RS1012A0	CIRCULAR ELEMENT 1365W 120V	1.000	PC	VI1220A1	4,2x12 TCB SELF-TAPPIN G SCREW	5.000	PC							
Code	Description	Qty	UOM																						
GN1326A1	ELEMENT SEALING	1.000	PC																						
RS1012A0	CIRCULAR ELEMENT 1365W 120V	1.000	PC																						
VI1220A1	4,2x12 TCB SELF-TAPPIN G SCREW	5.000	PC																						
KRS1011A	ROBERTA/LISA HEATING ELEMENT KIT	<table border="1"> <thead> <tr> <th>Code</th> <th>Description</th> <th>Qty</th> <th>UOM</th> </tr> </thead> <tbody> <tr> <td>GN1326A1</td> <td>ELEMENT SEALING</td> <td>1.000</td> <td>PC</td> </tr> <tr> <td>RS1011A0</td> <td>2560W 220-230V HEATING ELEMENT</td> <td>1.000</td> <td>PC</td> </tr> <tr> <td>SL1045A0</td> <td>S57 BLACK SILICONE - 80ml CARTRIDGE</td> <td>1.000</td> <td>PC</td> </tr> <tr> <td>VI1220A1</td> <td>4,2x12 TCB SELF-TAPPIN G SCREW</td> <td>5.000</td> <td>PC</td> </tr> </tbody> </table>	Code	Description	Qty	UOM	GN1326A1	ELEMENT SEALING	1.000	PC	RS1011A0	2560W 220-230V HEATING ELEMENT	1.000	PC	SL1045A0	S57 BLACK SILICONE - 80ml CARTRIDGE	1.000	PC	VI1220A1	4,2x12 TCB SELF-TAPPIN G SCREW	5.000	PC			
Code	Description	Qty	UOM																						
GN1326A1	ELEMENT SEALING	1.000	PC																						
RS1011A0	2560W 220-230V HEATING ELEMENT	1.000	PC																						
SL1045A0	S57 BLACK SILICONE - 80ml CARTRIDGE	1.000	PC																						
VI1220A1	4,2x12 TCB SELF-TAPPIN G SCREW	5.000	PC																						

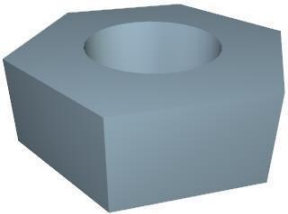

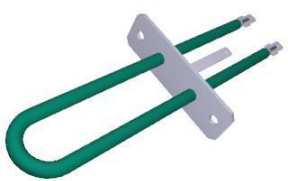
COMPONENT			SPARE PART																										
Code	Description	Image	Code	Description	Kit components																								
GN1326A	ELEMENT SEALING		KRS0090A	HEATING ELEMENT 1.26kW	<table border="1"> <thead> <tr> <th>Code</th> <th>Description</th> <th>Qty</th> <th>UOM</th> </tr> </thead> <tbody> <tr> <td>GN1326A1</td> <td>ELEMENT SEALING</td> <td>1.000</td> <td>PC</td> </tr> <tr> <td>RS0090A0</td> <td>CIRC. HEAT. ELEMENT 1260W 220-230</td> <td>1.000</td> <td>PC</td> </tr> <tr> <td>VI1220A1</td> <td>4,2x12 TCB SELF-TAPPIN G SCREW</td> <td>3.000</td> <td>PC</td> </tr> <tr> <td>VM1794A0</td> <td>250x4.8 PA66 BLACK CLAMP</td> <td>2.000</td> <td>PC</td> </tr> <tr> <td>VM2103A0</td> <td>CLAMP LOCK</td> <td>2.000</td> <td>PC</td> </tr> </tbody> </table>	Code	Description	Qty	UOM	GN1326A1	ELEMENT SEALING	1.000	PC	RS0090A0	CIRC. HEAT. ELEMENT 1260W 220-230	1.000	PC	VI1220A1	4,2x12 TCB SELF-TAPPIN G SCREW	3.000	PC	VM1794A0	250x4.8 PA66 BLACK CLAMP	2.000	PC	VM2103A0	CLAMP LOCK	2.000	PC
					Code	Description	Qty	UOM																					
					GN1326A1	ELEMENT SEALING	1.000	PC																					
					RS0090A0	CIRC. HEAT. ELEMENT 1260W 220-230	1.000	PC																					
					VI1220A1	4,2x12 TCB SELF-TAPPIN G SCREW	3.000	PC																					
			VM1794A0	250x4.8 PA66 BLACK CLAMP	2.000	PC																							
			VM2103A0	CLAMP LOCK	2.000	PC																							
			KRS0050A	HEATING ELEMENT KIT 0.5kW	<table border="1"> <thead> <tr> <th>Code</th> <th>Description</th> <th>Qty</th> <th>UOM</th> </tr> </thead> <tbody> <tr> <td>GN1326A1</td> <td>ELEMENT SEALING</td> <td>1.000</td> <td>PC</td> </tr> <tr> <td>RS0050A0</td> <td>HEAT. ELEMENT 500W 220-230V LIEV</td> <td>1.000</td> <td>PC</td> </tr> <tr> <td>VI1220A1</td> <td>4,2x12 TCB SELF-TAPPIN G SCREW</td> <td>2.000</td> <td>PC</td> </tr> </tbody> </table>	Code	Description	Qty	UOM	GN1326A1	ELEMENT SEALING	1.000	PC	RS0050A0	HEAT. ELEMENT 500W 220-230V LIEV	1.000	PC	VI1220A1	4,2x12 TCB SELF-TAPPIN G SCREW	2.000	PC								
					Code	Description	Qty	UOM																					
					GN1326A1	ELEMENT SEALING	1.000	PC																					
			RS0050A0	HEAT. ELEMENT 500W 220-230V LIEV	1.000	PC																							
			VI1220A1	4,2x12 TCB SELF-TAPPIN G SCREW	2.000	PC																							
			KRS0011A	HEATING ELEMENT 1.465kW RS0011A	<table border="1"> <thead> <tr> <th>Code</th> <th>Description</th> <th>Qty</th> <th>UOM</th> </tr> </thead> <tbody> <tr> <td>GN1326A1</td> <td>ELEMENT SEALING</td> <td>1.000</td> <td>PC</td> </tr> <tr> <td>RS0011A0</td> <td>CIRC.HEAT. ELEMENT 1465W 220-230</td> <td>1.000</td> <td>PC</td> </tr> <tr> <td>VI1220A1</td> <td>4,2x12 TCB SELF-TAPPIN G SCREW</td> <td>3.000</td> <td>PC</td> </tr> <tr> <td>VM1794A0</td> <td>250x4.8 PA66 BLACK CLAMP</td> <td>2.000</td> <td>PC</td> </tr> <tr> <td>VM2103A0</td> <td>CLAMP LOCK</td> <td>2.000</td> <td>PC</td> </tr> </tbody> </table>	Code	Description	Qty	UOM	GN1326A1	ELEMENT SEALING	1.000	PC	RS0011A0	CIRC.HEAT. ELEMENT 1465W 220-230	1.000	PC	VI1220A1	4,2x12 TCB SELF-TAPPIN G SCREW	3.000	PC	VM1794A0	250x4.8 PA66 BLACK CLAMP	2.000	PC	VM2103A0	CLAMP LOCK	2.000	PC
Code	Description	Qty			UOM																								
GN1326A1	ELEMENT SEALING	1.000			PC																								
RS0011A0	CIRC.HEAT. ELEMENT 1465W 220-230	1.000			PC																								
VI1220A1	4,2x12 TCB SELF-TAPPIN G SCREW	3.000			PC																								
VM1794A0	250x4.8 PA66 BLACK CLAMP	2.000	PC																										
VM2103A0	CLAMP LOCK	2.000	PC																										
KRS0010A	KIT HEATING ELEMENT RS10010A	<table border="1"> <thead> <tr> <th>Code</th> <th>Description</th> <th>Qty</th> <th>UOM</th> </tr> </thead> <tbody> <tr> <td>GN1326A1</td> <td>ELEMENT SEALING</td> <td>1.000</td> <td>PC</td> </tr> <tr> <td>RS0010A0</td> <td>CIRC.HEAT. ELEMENT 2560W - 220-230 V</td> <td>1.000</td> <td>PC</td> </tr> <tr> <td>VI1220A1</td> <td>4,2x12 TCB SELF-TAPPIN G SCREW</td> <td>3.000</td> <td>PC</td> </tr> </tbody> </table>	Code	Description	Qty	UOM	GN1326A1	ELEMENT SEALING	1.000	PC	RS0010A0	CIRC.HEAT. ELEMENT 2560W - 220-230 V	1.000	PC	VI1220A1	4,2x12 TCB SELF-TAPPIN G SCREW	3.000	PC											
		Code	Description	Qty	UOM																								
		GN1326A1	ELEMENT SEALING	1.000	PC																								
RS0010A0	CIRC.HEAT. ELEMENT 2560W - 220-230 V	1.000	PC																										
VI1220A1	4,2x12 TCB SELF-TAPPIN G SCREW	3.000	PC																										
KGN1326A	HEATING ELEMENT GASKET 5 PCS KIT	<table border="1"> <thead> <tr> <th>Code</th> <th>Description</th> <th>Qty</th> <th>UOM</th> </tr> </thead> <tbody> <tr> <td>GN1326A1</td> <td>ELEMENT SEALING</td> <td>5.000</td> <td>PC</td> </tr> </tbody> </table>	Code	Description	Qty	UOM	GN1326A1	ELEMENT SEALING	5.000	PC																			
		Code	Description	Qty	UOM																								
GN1326A1	ELEMENT SEALING	5.000	PC																										

COMPONENT			SPARE PART																						
Code	Description	Image	Code	Description	Kit components																				
GN1662A	GN1626A- XV300 DOOR GASKET 1952MM		KGN1662A	300 SERIES CT/CLUX DOOR GASKET KIT	<table border="1"> <thead> <tr> <th>Code</th> <th>Description</th> <th>Qty</th> <th>UOM</th> </tr> </thead> <tbody> <tr> <td>GN1662A0</td> <td>GN1626A- XV300 DOOR GASKET 1952MM</td> <td>1.000</td> <td>PC</td> </tr> <tr> <td>VM2277A0</td> <td>DOOR SEAL KIT INTERNAL CONNECTION</td> <td>1.000</td> <td>PC</td> </tr> </tbody> </table>	Code	Description	Qty	UOM	GN1662A0	GN1626A- XV300 DOOR GASKET 1952MM	1.000	PC	VM2277A0	DOOR SEAL KIT INTERNAL CONNECTION	1.000	PC								
					Code	Description	Qty	UOM																	
GN1662A0	GN1626A- XV300 DOOR GASKET 1952MM	1.000	PC																						
VM2277A0	DOOR SEAL KIT INTERNAL CONNECTION	1.000	PC																						
RC1170A	M14 H=7 CH=22 STAINLESS STEEL NUT		KRC1170A	M14 H8 CH22 NUT - 10 PCS. KIT	<table border="1"> <thead> <tr> <th>Code</th> <th>Description</th> <th>Qty</th> <th>UOM</th> </tr> </thead> <tbody> <tr> <td>RC1170A1</td> <td>M14 H=7 CH=22 STAINLESS STEEL NUT</td> <td>10.000</td> <td>PC</td> </tr> </tbody> </table>	Code	Description	Qty	UOM	RC1170A1	M14 H=7 CH=22 STAINLESS STEEL NUT	10.000	PC												
Code	Description	Qty	UOM																						
RC1170A1	M14 H=7 CH=22 STAINLESS STEEL NUT	10.000	PC																						
RS1002A	6750W 230V D230 6 TURNS HEATING ELEMENT		KRS1002A	6750W 230V HEATING ELEMENT KIT	<table border="1"> <thead> <tr> <th>Code</th> <th>Description</th> <th>Qty</th> <th>UOM</th> </tr> </thead> <tbody> <tr> <td>GN1671A0</td> <td>141X22 G8.5 ELEMENT ARMED GASKET</td> <td>1.000</td> <td>PC</td> </tr> <tr> <td>RS1002A1</td> <td>6750W 230V D230 6 TURNS HEATING ELEMENT</td> <td>1.000</td> <td>PC</td> </tr> <tr> <td>SL1045A0</td> <td>S57 BLACK SILICONE - 80ml CARTRIDGE</td> <td>1.000</td> <td>PC</td> </tr> <tr> <td>VI1220A1</td> <td>4,2x12 TCB SELF-TAPPIN G SCREW</td> <td>5.000</td> <td>PC</td> </tr> </tbody> </table>	Code	Description	Qty	UOM	GN1671A0	141X22 G8.5 ELEMENT ARMED GASKET	1.000	PC	RS1002A1	6750W 230V D230 6 TURNS HEATING ELEMENT	1.000	PC	SL1045A0	S57 BLACK SILICONE - 80ml CARTRIDGE	1.000	PC	VI1220A1	4,2x12 TCB SELF-TAPPIN G SCREW	5.000	PC
					Code	Description	Qty	UOM																	
					GN1671A0	141X22 G8.5 ELEMENT ARMED GASKET	1.000	PC																	
					RS1002A1	6750W 230V D230 6 TURNS HEATING ELEMENT	1.000	PC																	
SL1045A0	S57 BLACK SILICONE - 80ml CARTRIDGE	1.000	PC																						
VI1220A1	4,2x12 TCB SELF-TAPPIN G SCREW	5.000	PC																						
RS1261A	BAKERLUXCHEFLU X MOTOR BRAKING ELEMENT		KRS1261A	122W MOTOR BEAKING ELEMENT KIT	<table border="1"> <thead> <tr> <th>Code</th> <th>Description</th> <th>Qty</th> <th>UOM</th> </tr> </thead> <tbody> <tr> <td>GN1326A1</td> <td>ELEMENT SEALING</td> <td>1.000</td> <td>PC</td> </tr> <tr> <td>RS1261A0</td> <td>BAKERLUXCH EFLUX MOTOR BRAKING ELEMENT</td> <td>1.000</td> <td>PC</td> </tr> <tr> <td>SL1045A0</td> <td>S57 BLACK SILICONE - 80ml CARTRIDGE</td> <td>1.000</td> <td>PC</td> </tr> <tr> <td>VI1220A1</td> <td>4,2x12 TCB SELF-TAPPIN G SCREW</td> <td>2.000</td> <td>PC</td> </tr> </tbody> </table>	Code	Description	Qty	UOM	GN1326A1	ELEMENT SEALING	1.000	PC	RS1261A0	BAKERLUXCH EFLUX MOTOR BRAKING ELEMENT	1.000	PC	SL1045A0	S57 BLACK SILICONE - 80ml CARTRIDGE	1.000	PC	VI1220A1	4,2x12 TCB SELF-TAPPIN G SCREW	2.000	PC
Code	Description	Qty	UOM																						
GN1326A1	ELEMENT SEALING	1.000	PC																						
RS1261A0	BAKERLUXCH EFLUX MOTOR BRAKING ELEMENT	1.000	PC																						
SL1045A0	S57 BLACK SILICONE - 80ml CARTRIDGE	1.000	PC																						
VI1220A1	4,2x12 TCB SELF-TAPPIN G SCREW	2.000	PC																						



COMPONENT			SPARE PART										
Code	Description	Image	Code	Description	Kit components								
TB1515A	EXTERNAL HUMIDITY PIPE + RC1165A0		TB1515A1	EXTERNAL HUMIDITY PIPE + RC1165A0									
TB2320A	XVC305E/705E INTERNAL HUMIDITY PIPE		TB2320A0	XVC305E/705E INTERNAL HUMIDITY PIPE									
VM1820A	LATERAL SUPPORTS M6 FIXING BOLT		KVM1820A	THUMB SCREW 10PCS KIT	<table border="1"> <thead> <tr> <th>Code</th> <th>Description</th> <th>Qty</th> <th>UOM</th> </tr> </thead> <tbody> <tr> <td>VM1820A0</td> <td>LATERAL SUPPORTS M6 FIXING BOLT</td> <td>10.000</td> <td>PC</td> </tr> </tbody> </table>	Code	Description	Qty	UOM	VM1820A0	LATERAL SUPPORTS M6 FIXING BOLT	10.000	PC
Code	Description	Qty	UOM										
VM1820A0	LATERAL SUPPORTS M6 FIXING BOLT	10.000	PC										



ASM2854A/0.D01 - External cover - FRONT

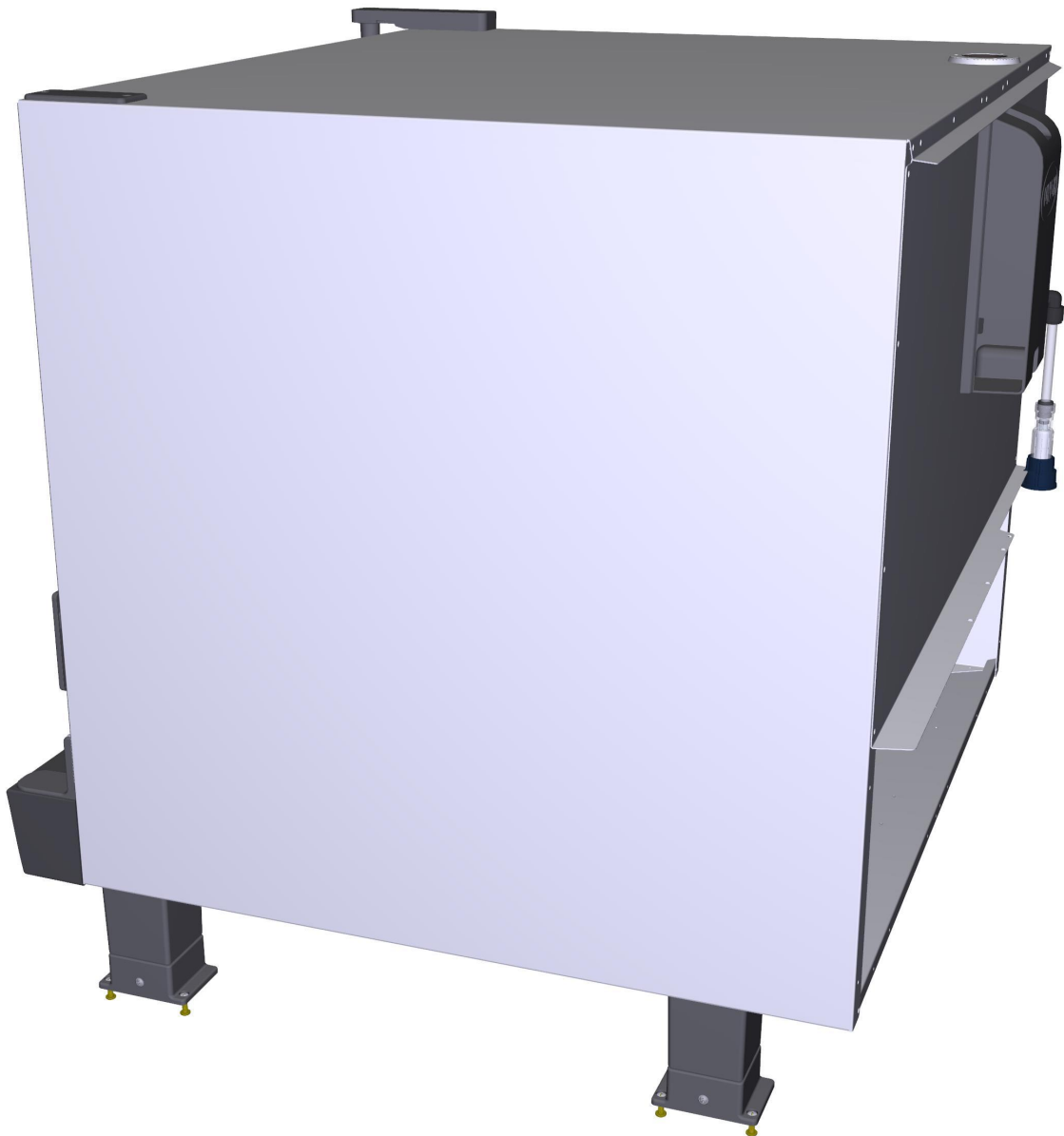





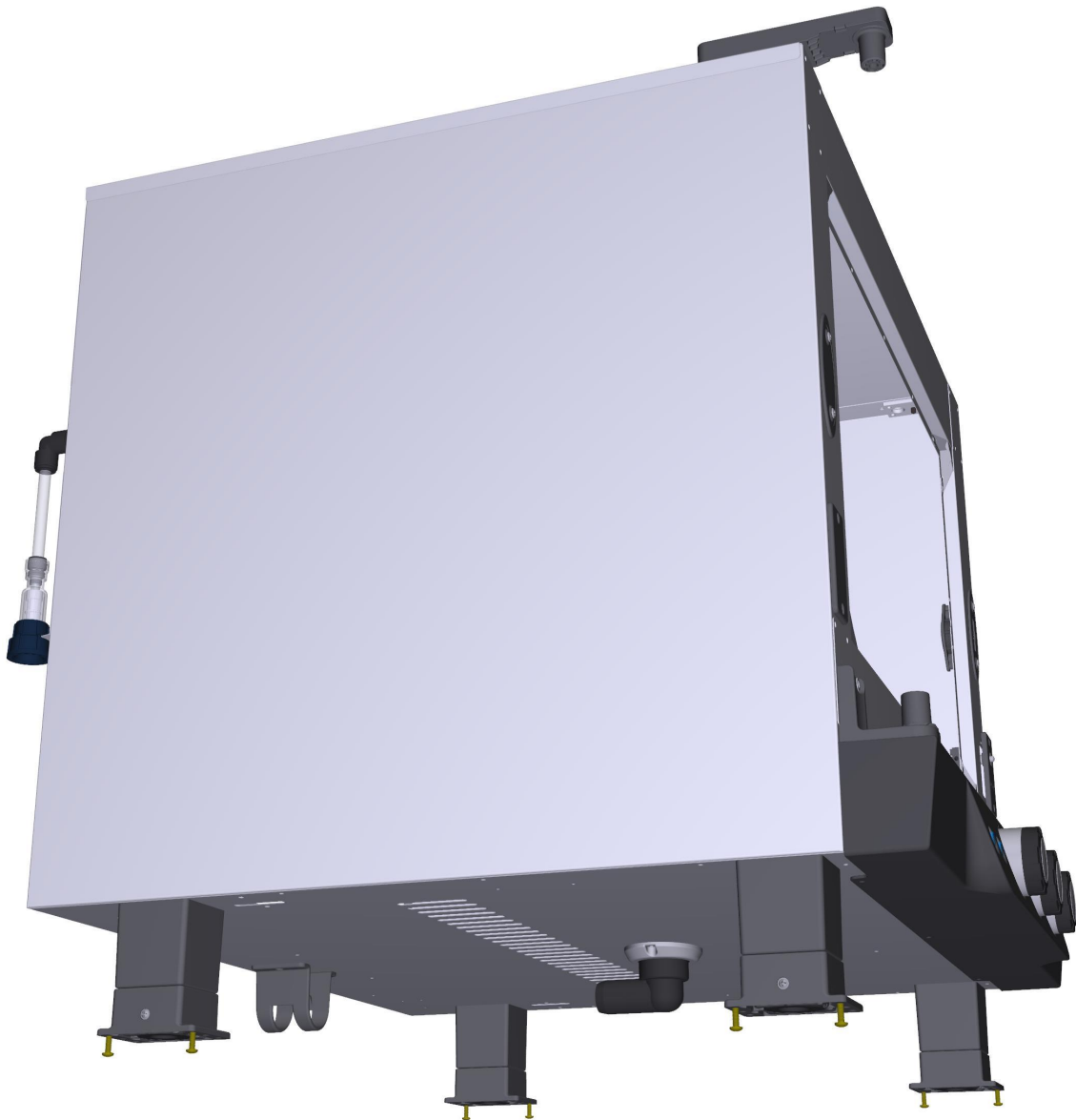

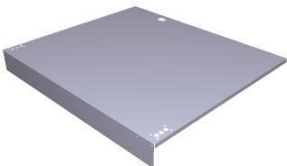

ASM2854A/0.D01 - External cover - REAR

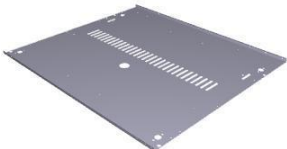



COMPONENT			SPARE PART		
Code	Description	Image	Code	Description	Kit components
0D2256A	CHEFLUX EXTERNAL COVER		0D2256A0	CHEFLUX EXTERNAL COVER	
0D2257A	CHEFLUX XV393 EXTERNAL LEFT PANEL		0D2257A0	CHEFLUX XV393 EXTERNAL LEFT PANEL	
0D2258A	CHEFLUX XV393 EXTERNAL RIGHT PANEL		0D2258A0	CHEFLUX XV393 EXTERNAL RIGHT PANEL	
0E1342A	CHEFLUX EXTERNAL BOTTOM PANEL		0E1342A0	CHEFLUX EXTERNAL BOTTOM PANEL	
0F1481A	CHEFLUX XV393 EXTERNAL BACK PANEL		0F1481A0	CHEFLUX XV393 EXTERNAL BACK PANEL	

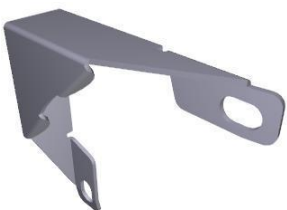
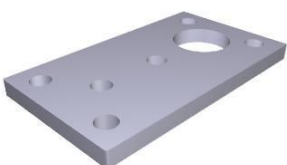
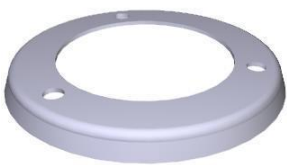



COMPONENT			SPARE PART		
Code	Description	Image	Code	Description	Kit components
0H1450A	XB-XV-XG ST. STEEL MUFFLE FRONT CORNER		0H1450A0	XB-XV-XG ST. STEEL MUFFLE FRONT CORNER	
0H2560A	XBC/XVC ZINC PLAT. DOOR COUNTERBRACKET		0H2560A0	XBC/XVC ZINC PLAT. DOOR COUNTERBRACKET	
0H3790A	CHIMNEY HOLDING PLATE		0H3790A0	CHIMNEY HOLDING PLATE	
0H6333A	BL CL THREADED DOOR COUNTER BRACKET		0H6333A0	BL CL THREADED DOOR COUNTER BRACKET	
0H7104A	CL CONTROL BOARD HOLDING PANEL		0H7104A0	CL CONTROL BOARD HOLDING PANEL	





COMPONENT			SPARE PART																		
Code	Description	Image	Code	Description	Kit components																
VE1295A	MK 16A 230V DOOR MICROSWITCH		KVE1295A	16A 230V DOOR MICROSWITCH KIT	<table border="1"> <thead> <tr> <th>Code</th> <th>Description</th> <th>Qty</th> <th>UOM</th> </tr> </thead> <tbody> <tr> <td>VE1295A0</td> <td>MK 16A 230V DOOR MICROSWITC</td> <td>1.000</td> <td>PC</td> </tr> </tbody> </table>	Code	Description	Qty	UOM	VE1295A0	MK 16A 230V DOOR MICROSWITC	1.000	PC								
Code	Description	Qty	UOM																		
VE1295A0	MK 16A 230V DOOR MICROSWITC	1.000	PC																		
VM1200A	DOOR MECHANIC MICROSWITCH SUPPORT PLATE		VM1200A0	DOOR MECHANIC MICROSWITCH SUPPORT PLATE																	
VM1555A	CT BT COOLING FAN SUPPORT		KVN1165A	1.5E ADVANCE/MM 230V COOLING FAN KIT	<table border="1"> <thead> <tr> <th>Code</th> <th>Description</th> <th>Qty</th> <th>UOM</th> </tr> </thead> <tbody> <tr> <td>VI1099A0</td> <td>SELF-DRILLIN G SCREW 4.8X13 TCB+ Z</td> <td>4.000</td> <td>PC</td> </tr> <tr> <td>VM1555A2</td> <td>CT BT COOLING FAN SUPPORT</td> <td>1.000</td> <td>PC</td> </tr> <tr> <td>VN1165A0</td> <td>230Vac 50/60Hz COOLING DOWN FAN</td> <td>1.000</td> <td>PC</td> </tr> </tbody> </table>	Code	Description	Qty	UOM	VI1099A0	SELF-DRILLIN G SCREW 4.8X13 TCB+ Z	4.000	PC	VM1555A2	CT BT COOLING FAN SUPPORT	1.000	PC	VN1165A0	230Vac 50/60Hz COOLING DOWN FAN	1.000	PC
Code	Description	Qty	UOM																		
VI1099A0	SELF-DRILLIN G SCREW 4.8X13 TCB+ Z	4.000	PC																		
VM1555A2	CT BT COOLING FAN SUPPORT	1.000	PC																		
VN1165A0	230Vac 50/60Hz COOLING DOWN FAN	1.000	PC																		
			KVN1164A	S.5/5E 12VDC COOLING DOWN FAN KIT	<table border="1"> <thead> <tr> <th>Code</th> <th>Description</th> <th>Qty</th> <th>UOM</th> </tr> </thead> <tbody> <tr> <td>VI1099A0</td> <td>SELF-DRILLIN G SCREW 4.8X13 TCB+ Z</td> <td>4.000</td> <td>PC</td> </tr> <tr> <td>VM1555A2</td> <td>CT BT COOLING FAN SUPPORT</td> <td>1.000</td> <td>PC</td> </tr> <tr> <td>VN1164A0</td> <td>12VDC COOLING DOWN FAN</td> <td>1.000</td> <td>PC</td> </tr> </tbody> </table>	Code	Description	Qty	UOM	VI1099A0	SELF-DRILLIN G SCREW 4.8X13 TCB+ Z	4.000	PC	VM1555A2	CT BT COOLING FAN SUPPORT	1.000	PC	VN1164A0	12VDC COOLING DOWN FAN	1.000	PC
Code	Description	Qty	UOM																		
VI1099A0	SELF-DRILLIN G SCREW 4.8X13 TCB+ Z	4.000	PC																		
VM1555A2	CT BT COOLING FAN SUPPORT	1.000	PC																		
VN1164A0	12VDC COOLING DOWN FAN	1.000	PC																		
VM1556A	XBC-XVC COOLING FAN GUARD		KVM1556A	XBC-XVC COOLING FAN GUARD KIT	<table border="1"> <thead> <tr> <th>Code</th> <th>Description</th> <th>Qty</th> <th>UOM</th> </tr> </thead> <tbody> <tr> <td>VM1556A0</td> <td>XBC-XVC COOLING FAN GUARD</td> <td>1.000</td> <td>PC</td> </tr> </tbody> </table>	Code	Description	Qty	UOM	VM1556A0	XBC-XVC COOLING FAN GUARD	1.000	PC								
Code	Description	Qty	UOM																		
VM1556A0	XBC-XVC COOLING FAN GUARD	1.000	PC																		



COMPONENT			SPARE PART																		
Code	Description	Image	Code	Description	Kit components																
VN1165A	230Vac 50/60Hz COOLING DOWN FA		KVN1165A	1.5E ADVANCE/MM 230V COOLING FAN KIT	<table border="1"> <thead> <tr> <th>Code</th> <th>Description</th> <th>Qty</th> <th>UOM</th> </tr> </thead> <tbody> <tr> <td>VH1099A0</td> <td>SELF-DRILLIN G SCREW 4.8X13 TCB+ Z</td> <td>4.000</td> <td>PC</td> </tr> <tr> <td>VM1555A2</td> <td>CT BT COOLING FAN SUPPORT</td> <td>1.000</td> <td>PC</td> </tr> <tr> <td>VN1165A0</td> <td>230Vac 50/60Hz COOLING DOWN FAN</td> <td>1.000</td> <td>PC</td> </tr> </tbody> </table>	Code	Description	Qty	UOM	VH1099A0	SELF-DRILLIN G SCREW 4.8X13 TCB+ Z	4.000	PC	VM1555A2	CT BT COOLING FAN SUPPORT	1.000	PC	VN1165A0	230Vac 50/60Hz COOLING DOWN FAN	1.000	PC
Code	Description	Qty	UOM																		
VH1099A0	SELF-DRILLIN G SCREW 4.8X13 TCB+ Z	4.000	PC																		
VM1555A2	CT BT COOLING FAN SUPPORT	1.000	PC																		
VN1165A0	230Vac 50/60Hz COOLING DOWN FAN	1.000	PC																		
EL1349A	CLIP TO FIX Ø10 mm CONNECTION JOIN		KEL1349A	Ø10 FITTING LOCKING CLIPS 10 PCS KIT	<table border="1"> <thead> <tr> <th>Code</th> <th>Description</th> <th>Qty</th> <th>UOM</th> </tr> </thead> <tbody> <tr> <td>EL1349A0</td> <td>CLIP TO FIX Ø10 mm CONNECTION JOINT</td> <td>10.000</td> <td>PC</td> </tr> </tbody> </table>	Code	Description	Qty	UOM	EL1349A0	CLIP TO FIX Ø10 mm CONNECTION JOINT	10.000	PC								
Code	Description	Qty	UOM																		
EL1349A0	CLIP TO FIX Ø10 mm CONNECTION JOINT	10.000	PC																		
RC1360A	10 - 10 JG ELBOW FITTING		KRC1360A	D10 - D10 JG ELBOW FITTING 10 PCS KIT	<table border="1"> <thead> <tr> <th>Code</th> <th>Description</th> <th>Qty</th> <th>UOM</th> </tr> </thead> <tbody> <tr> <td>RC1360A0</td> <td>10 - 10 JG ELBOW FITTIN</td> <td>10.000</td> <td>PC</td> </tr> </tbody> </table>	Code	Description	Qty	UOM	RC1360A0	10 - 10 JG ELBOW FITTIN	10.000	PC								
Code	Description	Qty	UOM																		
RC1360A0	10 - 10 JG ELBOW FITTIN	10.000	PC																		
TB1099A	TB3130A-D10 WATER CONNECTING PIPE		KTB2599A KTB2598A	Ø10 PET WATER PIPE TB2243A0 100M KIT D10 PET HUMIDITY PIPE TB2243A0 3 M KIT	<table border="1"> <thead> <tr> <th>Code</th> <th>Description</th> <th>Qty</th> <th>UOM</th> </tr> </thead> <tbody> <tr> <td>TB2243A0</td> <td>D10 PE TRANSPAREN T PIPE</td> <td>100.000</td> <td>M</td> </tr> <tr> <td>TB2243A0</td> <td>D10 PE TRANSPAREN T PIPE</td> <td>3.000</td> <td>M</td> </tr> </tbody> </table>	Code	Description	Qty	UOM	TB2243A0	D10 PE TRANSPAREN T PIPE	100.000	M	TB2243A0	D10 PE TRANSPAREN T PIPE	3.000	M				
Code	Description	Qty	UOM																		
TB2243A0	D10 PE TRANSPAREN T PIPE	100.000	M																		
TB2243A0	D10 PE TRANSPAREN T PIPE	3.000	M																		
VL1135A	3/4-JG10 CONNECTOR + FILTER AND NRV		KVL1135A	3/4-JG10 FITTING WITH FILTER AND VNR KIT	<table border="1"> <thead> <tr> <th>Code</th> <th>Description</th> <th>Qty</th> <th>UOM</th> </tr> </thead> <tbody> <tr> <td>RC1360A0</td> <td>10 - 10 JG ELBOW FITTIN</td> <td>1.000</td> <td>PC</td> </tr> <tr> <td>VL1135A1</td> <td>3/4-JG10 CONNECTOR + FILTER AND NRV</td> <td>1.000</td> <td>PC</td> </tr> </tbody> </table>	Code	Description	Qty	UOM	RC1360A0	10 - 10 JG ELBOW FITTIN	1.000	PC	VL1135A1	3/4-JG10 CONNECTOR + FILTER AND NRV	1.000	PC				
Code	Description	Qty	UOM																		
RC1360A0	10 - 10 JG ELBOW FITTIN	1.000	PC																		
VL1135A1	3/4-JG10 CONNECTOR + FILTER AND NRV	1.000	PC																		



COMPONENT			SPARE PART																																																																																						
Code	Description	Image	Code	Description	Kit components																																																																																				
VL1026A	BEND FOR DRAIN PIPE		KVL1026A	DRAIN PIPE BEND KI	<table border="1"> <thead> <tr> <th>Code</th> <th>Description</th> <th>Qty</th> <th>UOM</th> </tr> </thead> <tbody> <tr> <td>GN1400A0</td> <td>U-TRAP SEAL</td> <td>1.000</td> <td>PC</td> </tr> <tr> <td>VL1026A0</td> <td>BEND FOR DRAIN PIPE</td> <td>1.000</td> <td>PC</td> </tr> <tr> <td>VM2039A0</td> <td>DRAIN BEND FIXING RING</td> <td>1.000</td> <td>PC</td> </tr> </tbody> </table>	Code	Description	Qty	UOM	GN1400A0	U-TRAP SEAL	1.000	PC	VL1026A0	BEND FOR DRAIN PIPE	1.000	PC	VM2039A0	DRAIN BEND FIXING RING	1.000	PC																																																																				
					Code	Description	Qty	UOM																																																																																	
GN1400A0	U-TRAP SEAL	1.000	PC																																																																																						
VL1026A0	BEND FOR DRAIN PIPE	1.000	PC																																																																																						
VM2039A0	DRAIN BEND FIXING RING	1.000	PC																																																																																						
VM2039A	DRAIN BEND FIXING RING		KVL1315A	CBX RECIRCULATION BOX KIT (NO PUMPS)	<table border="1"> <thead> <tr> <th>Code</th> <th>Description</th> <th>Qty</th> <th>UOM</th> </tr> </thead> <tbody> <tr> <td>0H6686A0</td> <td></td> <td>1.000</td> <td>PC</td> </tr> <tr> <td>GN1400A0</td> <td>U-TRAP SEAL</td> <td>1.000</td> <td>PC</td> </tr> <tr> <td>RC1019A0</td> <td>D=10 ELASTIC CLAMP</td> <td>2.000</td> <td>PC</td> </tr> <tr> <td>RC1243A0</td> <td>Ø10F-Ø10M ELBOW CONNECTION + JG END KIT</td> <td>1.000</td> <td>PC</td> </tr> <tr> <td>RC1360A0</td> <td>10 - 10 JG ELBOW FITTING</td> <td>2.000</td> <td>PC</td> </tr> <tr> <td>RC1378A0</td> <td>HOSE CLAMP</td> <td>1.000</td> <td>PC</td> </tr> <tr> <td>RC1410A0</td> <td>ST STEEL HOSE CLAMP D16-27</td> <td>2.000</td> <td>PC</td> </tr> <tr> <td>SN1053A0</td> <td></td> <td>1.000</td> <td>PC</td> </tr> <tr> <td>SN1061A0</td> <td>D4x175MM NTC PROBE</td> <td>1.000</td> <td>PC</td> </tr> <tr> <td>TB3822A0</td> <td></td> <td>1.000</td> <td>PC</td> </tr> <tr> <td>TB4135A0</td> <td></td> <td>1.000</td> <td>PC</td> </tr> <tr> <td>TB4160A0</td> <td></td> <td>1.000</td> <td>PC</td> </tr> <tr> <td>VI1103A0</td> <td>40X12 TBSP SCREW FOR PLASTIC</td> <td>6.000</td> <td>PC</td> </tr> <tr> <td>VL1315A1</td> <td>ASM TANK BLOCK PUMPS DID</td> <td>1.000</td> <td>PC</td> </tr> <tr> <td>VL1340A0</td> <td>DID JG 10 M-M BYPASS CONNECTION</td> <td>1.000</td> <td>PC</td> </tr> <tr> <td>VL1400A0</td> <td>PARTIAL EDGE BENT DRAIN</td> <td>1.000</td> <td>PC</td> </tr> <tr> <td>VL1407A1</td> <td>DID PRESSURE REDUCER ASSEMBLY</td> <td>1.000</td> <td>PC</td> </tr> <tr> <td>VM1802A0</td> <td>DID TANKS FLAP PIN</td> <td>1.000</td> <td>PC</td> </tr> <tr> <td>VM2039A0</td> <td>DRAIN BEND FIXING RING</td> <td>1.000</td> <td>PC</td> </tr> <tr> <td>VM2640A0</td> <td>DRAIN PUMP PROTECTION</td> <td>1.000</td> <td>PC</td> </tr> </tbody> </table>	Code	Description	Qty	UOM	0H6686A0		1.000	PC	GN1400A0	U-TRAP SEAL	1.000	PC	RC1019A0	D=10 ELASTIC CLAMP	2.000	PC	RC1243A0	Ø10F-Ø10M ELBOW CONNECTION + JG END KIT	1.000	PC	RC1360A0	10 - 10 JG ELBOW FITTING	2.000	PC	RC1378A0	HOSE CLAMP	1.000	PC	RC1410A0	ST STEEL HOSE CLAMP D16-27	2.000	PC	SN1053A0		1.000	PC	SN1061A0	D4x175MM NTC PROBE	1.000	PC	TB3822A0		1.000	PC	TB4135A0		1.000	PC	TB4160A0		1.000	PC	VI1103A0	40X12 TBSP SCREW FOR PLASTIC	6.000	PC	VL1315A1	ASM TANK BLOCK PUMPS DID	1.000	PC	VL1340A0	DID JG 10 M-M BYPASS CONNECTION	1.000	PC	VL1400A0	PARTIAL EDGE BENT DRAIN	1.000	PC	VL1407A1	DID PRESSURE REDUCER ASSEMBLY	1.000	PC	VM1802A0	DID TANKS FLAP PIN	1.000	PC	VM2039A0	DRAIN BEND FIXING RING	1.000	PC	VM2640A0	DRAIN PUMP PROTECTION	1.000	PC
					Code	Description	Qty	UOM																																																																																	
					0H6686A0		1.000	PC																																																																																	
					GN1400A0	U-TRAP SEAL	1.000	PC																																																																																	
					RC1019A0	D=10 ELASTIC CLAMP	2.000	PC																																																																																	
					RC1243A0	Ø10F-Ø10M ELBOW CONNECTION + JG END KIT	1.000	PC																																																																																	
					RC1360A0	10 - 10 JG ELBOW FITTING	2.000	PC																																																																																	
					RC1378A0	HOSE CLAMP	1.000	PC																																																																																	
					RC1410A0	ST STEEL HOSE CLAMP D16-27	2.000	PC																																																																																	
					SN1053A0		1.000	PC																																																																																	
					SN1061A0	D4x175MM NTC PROBE	1.000	PC																																																																																	
					TB3822A0		1.000	PC																																																																																	
					TB4135A0		1.000	PC																																																																																	
					TB4160A0		1.000	PC																																																																																	
					VI1103A0	40X12 TBSP SCREW FOR PLASTIC	6.000	PC																																																																																	
					VL1315A1	ASM TANK BLOCK PUMPS DID	1.000	PC																																																																																	
					VL1340A0	DID JG 10 M-M BYPASS CONNECTION	1.000	PC																																																																																	
					VL1400A0	PARTIAL EDGE BENT DRAIN	1.000	PC																																																																																	
					VL1407A1	DID PRESSURE REDUCER ASSEMBLY	1.000	PC																																																																																	
					VM1802A0	DID TANKS FLAP PIN	1.000	PC																																																																																	
VM2039A0	DRAIN BEND FIXING RING	1.000	PC																																																																																						
VM2640A0	DRAIN PUMP PROTECTION	1.000	PC																																																																																						



COMPONENT			SPARE PART																																																																																																														
Code	Description	Image	Code	Description	Kit components																																																																																																												
VM2039A	DRAIN BEND FIXING RING		KVL1310A	COMPLETE CBX RECIRC TANK GROUP KIT	<table border="1"> <thead> <tr> <th>Code</th> <th>Description</th> <th>Qty</th> <th>UOM</th> </tr> </thead> <tbody> <tr> <td>0H5760A0</td> <td>CN1016 CAPACITOR COVER</td> <td>1.000</td> <td>PC</td> </tr> <tr> <td>0H6686A0</td> <td></td> <td>1.000</td> <td>PC</td> </tr> <tr> <td>CE2054A0</td> <td>DRAIN PUMP RAST 5 CABLE</td> <td>1.000</td> <td>PC</td> </tr> <tr> <td>CE2055A0</td> <td>CAVO RAST 5 POMPA RICIRCOLO</td> <td>1.000</td> <td>PC</td> </tr> <tr> <td>CN1016A0</td> <td>CE/UL 500V 2.5 uF CAPACITO</td> <td>1.000</td> <td>PC</td> </tr> <tr> <td>GN1400A0</td> <td>U-TRAP SEAL</td> <td>1.000</td> <td>PC</td> </tr> <tr> <td>PM1013A0</td> <td>240V 32W DRAIN PUMP</td> <td>1.000</td> <td>PC</td> </tr> <tr> <td>PM1018A0</td> <td>240V 100W RECYCLING PUMP</td> <td>1.000</td> <td>PC</td> </tr> <tr> <td>RC1019A0</td> <td>D=10 ELASTIC CLAMP</td> <td>2.000</td> <td>PC</td> </tr> <tr> <td>RC1046A0</td> <td>D10-16 H9 ST STEEL HOSE CLAMP</td> <td>1.000</td> <td>PC</td> </tr> <tr> <td>RC1360A0</td> <td>10 - 10 JG ELBOW FITTIN</td> <td>2.000</td> <td>PC</td> </tr> <tr> <td>RC1378A0</td> <td>HOSE CLAMP</td> <td>1.000</td> <td>PC</td> </tr> <tr> <td>RC1410A0</td> <td>ST STEEL HOSE CLAMP D16-27</td> <td>6.000</td> <td>PC</td> </tr> <tr> <td>SN1053A0</td> <td></td> <td>1.000</td> <td>PC</td> </tr> <tr> <td>SN1061A0</td> <td>D4x175MM NTC PROBE</td> <td>1.000</td> <td>PC</td> </tr> <tr> <td>TB3822A0</td> <td></td> <td>2.000</td> <td>PC</td> </tr> <tr> <td>TB4135A0</td> <td></td> <td>1.000</td> <td>PC</td> </tr> <tr> <td>TB4160A0</td> <td></td> <td>1.000</td> <td>PC</td> </tr> <tr> <td>VH1103A0</td> <td>40X12 TBSP SCREW FOR PLASTIC</td> <td>9.000</td> <td>PC</td> </tr> <tr> <td>VH1220A1</td> <td>4,2x12 TCB SELF-TAPPIN G SCREW</td> <td>2.000</td> <td>PC</td> </tr> <tr> <td>VH1931A0</td> <td>M8x1.65 H4 CH13 ZINC PLATED NUT</td> <td>1.000</td> <td>PC</td> </tr> <tr> <td>VL1178A0</td> <td>EPDM O-RIN INNER D 10.8 STRING 1.78</td> <td>2.000</td> <td>PC</td> </tr> <tr> <td>VL1315A1</td> <td>ASM TANK BLOCK PUMPS DID</td> <td>1.000</td> <td>PC</td> </tr> <tr> <td>VL1318A1</td> <td>SUPPORTO POMPA RICIRCOLO DI</td> <td>1.000</td> <td>PC</td> </tr> <tr> <td>VL1329A0</td> <td>D24-D16 FITTING</td> <td>1.000</td> <td>PC</td> </tr> <tr> <td>VL1332A0</td> <td>DID TANK CAP</td> <td>1.000</td> <td>PC</td> </tr> </tbody> </table>	Code	Description	Qty	UOM	0H5760A0	CN1016 CAPACITOR COVER	1.000	PC	0H6686A0		1.000	PC	CE2054A0	DRAIN PUMP RAST 5 CABLE	1.000	PC	CE2055A0	CAVO RAST 5 POMPA RICIRCOLO	1.000	PC	CN1016A0	CE/UL 500V 2.5 uF CAPACITO	1.000	PC	GN1400A0	U-TRAP SEAL	1.000	PC	PM1013A0	240V 32W DRAIN PUMP	1.000	PC	PM1018A0	240V 100W RECYCLING PUMP	1.000	PC	RC1019A0	D=10 ELASTIC CLAMP	2.000	PC	RC1046A0	D10-16 H9 ST STEEL HOSE CLAMP	1.000	PC	RC1360A0	10 - 10 JG ELBOW FITTIN	2.000	PC	RC1378A0	HOSE CLAMP	1.000	PC	RC1410A0	ST STEEL HOSE CLAMP D16-27	6.000	PC	SN1053A0		1.000	PC	SN1061A0	D4x175MM NTC PROBE	1.000	PC	TB3822A0		2.000	PC	TB4135A0		1.000	PC	TB4160A0		1.000	PC	VH1103A0	40X12 TBSP SCREW FOR PLASTIC	9.000	PC	VH1220A1	4,2x12 TCB SELF-TAPPIN G SCREW	2.000	PC	VH1931A0	M8x1.65 H4 CH13 ZINC PLATED NUT	1.000	PC	VL1178A0	EPDM O-RIN INNER D 10.8 STRING 1.78	2.000	PC	VL1315A1	ASM TANK BLOCK PUMPS DID	1.000	PC	VL1318A1	SUPPORTO POMPA RICIRCOLO DI	1.000	PC	VL1329A0	D24-D16 FITTING	1.000	PC	VL1332A0	DID TANK CAP	1.000	PC
Code	Description	Qty	UOM																																																																																																														
0H5760A0	CN1016 CAPACITOR COVER	1.000	PC																																																																																																														
0H6686A0		1.000	PC																																																																																																														
CE2054A0	DRAIN PUMP RAST 5 CABLE	1.000	PC																																																																																																														
CE2055A0	CAVO RAST 5 POMPA RICIRCOLO	1.000	PC																																																																																																														
CN1016A0	CE/UL 500V 2.5 uF CAPACITO	1.000	PC																																																																																																														
GN1400A0	U-TRAP SEAL	1.000	PC																																																																																																														
PM1013A0	240V 32W DRAIN PUMP	1.000	PC																																																																																																														
PM1018A0	240V 100W RECYCLING PUMP	1.000	PC																																																																																																														
RC1019A0	D=10 ELASTIC CLAMP	2.000	PC																																																																																																														
RC1046A0	D10-16 H9 ST STEEL HOSE CLAMP	1.000	PC																																																																																																														
RC1360A0	10 - 10 JG ELBOW FITTIN	2.000	PC																																																																																																														
RC1378A0	HOSE CLAMP	1.000	PC																																																																																																														
RC1410A0	ST STEEL HOSE CLAMP D16-27	6.000	PC																																																																																																														
SN1053A0		1.000	PC																																																																																																														
SN1061A0	D4x175MM NTC PROBE	1.000	PC																																																																																																														
TB3822A0		2.000	PC																																																																																																														
TB4135A0		1.000	PC																																																																																																														
TB4160A0		1.000	PC																																																																																																														
VH1103A0	40X12 TBSP SCREW FOR PLASTIC	9.000	PC																																																																																																														
VH1220A1	4,2x12 TCB SELF-TAPPIN G SCREW	2.000	PC																																																																																																														
VH1931A0	M8x1.65 H4 CH13 ZINC PLATED NUT	1.000	PC																																																																																																														
VL1178A0	EPDM O-RIN INNER D 10.8 STRING 1.78	2.000	PC																																																																																																														
VL1315A1	ASM TANK BLOCK PUMPS DID	1.000	PC																																																																																																														
VL1318A1	SUPPORTO POMPA RICIRCOLO DI	1.000	PC																																																																																																														
VL1329A0	D24-D16 FITTING	1.000	PC																																																																																																														
VL1332A0	DID TANK CAP	1.000	PC																																																																																																														





COMPONENT			SPARE PART																																		
Code	Description	Image	Code	Description	Kit components																																
VM2039A	DRAIN BEND FIXING RING		KVL1310A	COMPLETE CBX RECIRC TANK GROUP KIT	<table border="1"> <thead> <tr> <th>Code</th> <th>Description</th> <th>Qty</th> <th>UOM</th> </tr> </thead> <tbody> <tr> <td>VL1340A0</td> <td>DID JG 10 M-M BYPASS CONNECTION</td> <td>1.000</td> <td>PC</td> </tr> <tr> <td>VL1400A0</td> <td>PARTIAL EDGE BENT DRAIN</td> <td>1.000</td> <td>PC</td> </tr> <tr> <td>VL1407A1</td> <td>DID PRESSURE REDUCER ASSEMBLY</td> <td>1.000</td> <td>PC</td> </tr> <tr> <td>VM1794A0</td> <td>250x4.8 PA66 BLACK CLAMP</td> <td>1.000</td> <td>PC</td> </tr> <tr> <td>VM1802A0</td> <td>DID TANKS FLAP PIN</td> <td>1.000</td> <td>PC</td> </tr> <tr> <td>VM2039A0</td> <td>DRAIN BEND FIXING RING</td> <td>1.000</td> <td>PC</td> </tr> <tr> <td>VM2640A0</td> <td>DRAIN PUMP PROTECTION</td> <td>1.000</td> <td>PC</td> </tr> </tbody> </table>	Code	Description	Qty	UOM	VL1340A0	DID JG 10 M-M BYPASS CONNECTION	1.000	PC	VL1400A0	PARTIAL EDGE BENT DRAIN	1.000	PC	VL1407A1	DID PRESSURE REDUCER ASSEMBLY	1.000	PC	VM1794A0	250x4.8 PA66 BLACK CLAMP	1.000	PC	VM1802A0	DID TANKS FLAP PIN	1.000	PC	VM2039A0	DRAIN BEND FIXING RING	1.000	PC	VM2640A0	DRAIN PUMP PROTECTION	1.000	PC
			Code		Description	Qty	UOM																														
VL1340A0	DID JG 10 M-M BYPASS CONNECTION	1.000	PC																																		
VL1400A0	PARTIAL EDGE BENT DRAIN	1.000	PC																																		
VL1407A1	DID PRESSURE REDUCER ASSEMBLY	1.000	PC																																		
VM1794A0	250x4.8 PA66 BLACK CLAMP	1.000	PC																																		
VM1802A0	DID TANKS FLAP PIN	1.000	PC																																		
VM2039A0	DRAIN BEND FIXING RING	1.000	PC																																		
VM2640A0	DRAIN PUMP PROTECTION	1.000	PC																																		
KVL1026A	DRAIN PIPE BEND KI	<table border="1"> <thead> <tr> <th>Code</th> <th>Description</th> <th>Qty</th> <th>UOM</th> </tr> </thead> <tbody> <tr> <td>GN1400A0</td> <td>U-TRAP SEAL</td> <td>1.000</td> <td>PC</td> </tr> <tr> <td>VL1026A0</td> <td>BEND FOR DRAIN PIPE</td> <td>1.000</td> <td>PC</td> </tr> <tr> <td>VM2039A0</td> <td>DRAIN BEND FIXING RING</td> <td>1.000</td> <td>PC</td> </tr> </tbody> </table>	Code		Description	Qty	UOM	GN1400A0	U-TRAP SEAL	1.000	PC	VL1026A0	BEND FOR DRAIN PIPE	1.000	PC	VM2039A0	DRAIN BEND FIXING RING	1.000	PC																		
Code		Description	Qty	UOM																																	
GN1400A0		U-TRAP SEAL	1.000	PC																																	
VL1026A0	BEND FOR DRAIN PIPE	1.000	PC																																		
VM2039A0	DRAIN BEND FIXING RING	1.000	PC																																		
0H1019A	BRACKET FOR CHEFTOP H100 FEE		K0H1019A	CT REINF. PLATE FOR H100 FEET	<table border="1"> <thead> <tr> <th>Code</th> <th>Description</th> <th>Qty</th> <th>UOM</th> </tr> </thead> <tbody> <tr> <td>0H1019A2</td> <td>BRACKET FOR CHEFTOP H100 FEET</td> <td>1.000</td> <td>PC</td> </tr> <tr> <td>VI1739A0</td> <td>ZINC THREAD INSERT M10 FTT/E STP</td> <td>2.000</td> <td>PC</td> </tr> </tbody> </table>	Code	Description	Qty	UOM	0H1019A2	BRACKET FOR CHEFTOP H100 FEET	1.000	PC	VI1739A0	ZINC THREAD INSERT M10 FTT/E STP	2.000	PC																				
Code	Description	Qty	UOM																																		
0H1019A2	BRACKET FOR CHEFTOP H100 FEET	1.000	PC																																		
VI1739A0	ZINC THREAD INSERT M10 FTT/E STP	2.000	PC																																		
PD1074A	H=100 SQUARE FOO		KPD1074A	Mind.Maps H100 FOOT KIT	<table border="1"> <thead> <tr> <th>Code</th> <th>Description</th> <th>Qty</th> <th>UOM</th> </tr> </thead> <tbody> <tr> <td>PD1101A0</td> <td></td> <td>1.000</td> <td>PC</td> </tr> <tr> <td>VI1220A1</td> <td>4.2x12 TCB SELF-TAPPING SCREW</td> <td>4.000</td> <td>PC</td> </tr> </tbody> </table>	Code	Description	Qty	UOM	PD1101A0		1.000	PC	VI1220A1	4.2x12 TCB SELF-TAPPING SCREW	4.000	PC																				
Code	Description	Qty	UOM																																		
PD1101A0		1.000	PC																																		
VI1220A1	4.2x12 TCB SELF-TAPPING SCREW	4.000	PC																																		



COMPONENT			SPARE PART																										
Code	Description	Image	Code	Description	Kit components																								
PD1075A	PD1074 FOOT LOCKING BRACKET		KPD1075A	OVEN FOOT STOPPING BRACKET 4 PCS KIT	<table border="1"> <thead> <tr> <th>Code</th> <th>Description</th> <th>Qty</th> <th>UOM</th> </tr> </thead> <tbody> <tr> <td>PD1075A1</td> <td>PD1074 FOOT LOCKING BRACKET</td> <td>4.000</td> <td>PC</td> </tr> <tr> <td>V11950A0</td> <td>ST. STEEL 4,2X13 TCB SELF-DRILLIN G SCREW</td> <td>8.000</td> <td>PC</td> </tr> </tbody> </table>	Code	Description	Qty	UOM	PD1075A1	PD1074 FOOT LOCKING BRACKET	4.000	PC	V11950A0	ST. STEEL 4,2X13 TCB SELF-DRILLIN G SCREW	8.000	PC												
					Code	Description	Qty	UOM																					
PD1075A1	PD1074 FOOT LOCKING BRACKET	4.000	PC																										
V11950A0	ST. STEEL 4,2X13 TCB SELF-DRILLIN G SCREW	8.000	PC																										
<table border="1"> <thead> <tr> <th>Code</th> <th>Description</th> <th>Qty</th> <th>UOM</th> </tr> </thead> <tbody> <tr> <td>MN1111A1</td> <td>CHEFLUX BAKERLUX THERMOSTAT KNOB</td> <td>1.000</td> <td>PC</td> </tr> </tbody> </table>	Code	Description	Qty	UOM	MN1111A1	CHEFLUX BAKERLUX THERMOSTAT KNOB	1.000	PC																					
Code	Description	Qty	UOM																										
MN1111A1	CHEFLUX BAKERLUX THERMOSTAT KNOB	1.000	PC																										
MN1112A	CHEFLUX BAKERLUX TIMER KNOB		KMN1112A	CHEFLUX/BAKERLU X TIMER KNOB KIT	<table border="1"> <thead> <tr> <th>Code</th> <th>Description</th> <th>Qty</th> <th>UOM</th> </tr> </thead> <tbody> <tr> <td>MN1112A1</td> <td>CHEFLUX BAKERLUX TIMER KNOB</td> <td>1.000</td> <td>PC</td> </tr> </tbody> </table>	Code	Description	Qty	UOM	MN1112A1	CHEFLUX BAKERLUX TIMER KNOB	1.000	PC																
					Code	Description	Qty	UOM																					
MN1112A1	CHEFLUX BAKERLUX TIMER KNOB	1.000	PC																										
<table border="1"> <thead> <tr> <th>Code</th> <th>Description</th> <th>Qty</th> <th>UOM</th> </tr> </thead> <tbody> <tr> <td>MN1113A2</td> <td>CHEFLUX BAKERLUX HUMIDITY CONTROL KNOB</td> <td>1.000</td> <td>PC</td> </tr> </tbody> </table>	Code	Description	Qty	UOM	MN1113A2	CHEFLUX BAKERLUX HUMIDITY CONTROL KNOB	1.000	PC																					
Code	Description	Qty	UOM																										
MN1113A2	CHEFLUX BAKERLUX HUMIDITY CONTROL KNOB	1.000	PC																										
TM1001C	15 SEC 120/240V BUZZER KIT		KTM1001C	15 SEC BUZZER KIT	<table border="1"> <thead> <tr> <th>Code</th> <th>Description</th> <th>Qty</th> <th>UOM</th> </tr> </thead> <tbody> <tr> <td>TM1001C3</td> <td>15 SEC 120/240V BUZZER KIT</td> <td>1.000</td> <td>PC</td> </tr> <tr> <td>V11220A1</td> <td>4,2x12 TCB SELF-TAPPIN G SCREW</td> <td>3.000</td> <td>PC</td> </tr> <tr> <td>V11850A0</td> <td>TCB M4x6 SCREW</td> <td>3.000</td> <td>PC</td> </tr> <tr> <td>VM1447A0</td> <td></td> <td>0.500</td> <td>PC</td> </tr> <tr> <td>VM1745A0</td> <td>CARD SUPPORT</td> <td>3.000</td> <td>PC</td> </tr> </tbody> </table>	Code	Description	Qty	UOM	TM1001C3	15 SEC 120/240V BUZZER KIT	1.000	PC	V11220A1	4,2x12 TCB SELF-TAPPIN G SCREW	3.000	PC	V11850A0	TCB M4x6 SCREW	3.000	PC	VM1447A0		0.500	PC	VM1745A0	CARD SUPPORT	3.000	PC
					Code	Description	Qty	UOM																					
TM1001C3	15 SEC 120/240V BUZZER KIT	1.000	PC																										
V11220A1	4,2x12 TCB SELF-TAPPIN G SCREW	3.000	PC																										
V11850A0	TCB M4x6 SCREW	3.000	PC																										
VM1447A0		0.500	PC																										
VM1745A0	CARD SUPPORT	3.000	PC																										
<table border="1"> <thead> <tr> <th>Code</th> <th>Description</th> <th>Qty</th> <th>UOM</th> </tr> </thead> <tbody> <tr> <td>MN1113A</td> <td>CHEFLUX BAKERLUX HUMIDITY CONTROL KNOB</td> <td>1.000</td> <td>PC</td> </tr> </tbody> </table>	Code	Description	Qty	UOM	MN1113A	CHEFLUX BAKERLUX HUMIDITY CONTROL KNOB	1.000	PC																					
Code	Description	Qty	UOM																										
MN1113A	CHEFLUX BAKERLUX HUMIDITY CONTROL KNOB	1.000	PC																										

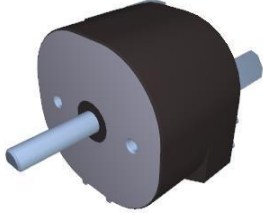
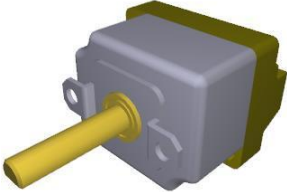
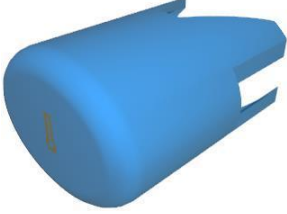

COMPONENT			SPARE PART																										
Code	Description	Image	Code	Description	Kit components																								
TM1005A	MI2 60 MIN 250V 16A TIMER		KTM1005A	60 MIN TIMER KIT	<table border="1"> <thead> <tr> <th>Code</th> <th>Description</th> <th>Qty</th> <th>UOM</th> </tr> </thead> <tbody> <tr> <td>TM1005A0</td> <td>MI2 60 MIN 250V 16A TIME</td> <td>1.000</td> <td>PC</td> </tr> <tr> <td>VI1850A0</td> <td>TCB M4x6 SCREW</td> <td>2.000</td> <td>PC</td> </tr> </tbody> </table>	Code	Description	Qty	UOM	TM1005A0	MI2 60 MIN 250V 16A TIME	1.000	PC	VI1850A0	TCB M4x6 SCREW	2.000	PC												
					Code	Description	Qty	UOM																					
TM1005A0	MI2 60 MIN 250V 16A TIME	1.000	PC																										
VI1850A0	TCB M4x6 SCREW	2.000	PC																										
<table border="1"> <thead> <tr> <th>Code</th> <th>Description</th> <th>Qty</th> <th>UOM</th> </tr> </thead> <tbody> <tr> <td>TR1100A0</td> <td>269°C 55.19052.80 ADJUSTABLE THERMOSTAT</td> <td>1.000</td> <td>PC</td> </tr> <tr> <td>VI1850A0</td> <td>TCB M4x6 SCREW</td> <td>2.000</td> <td>PC</td> </tr> </tbody> </table>	Code	Description	Qty	UOM	TR1100A0	269°C 55.19052.80 ADJUSTABLE THERMOSTAT	1.000	PC	VI1850A0	TCB M4x6 SCREW	2.000	PC																	
Code	Description	Qty	UOM																										
TR1100A0	269°C 55.19052.80 ADJUSTABLE THERMOSTAT	1.000	PC																										
VI1850A0	TCB M4x6 SCREW	2.000	PC																										
TR1100A	269°C 55.19052.80 ADJUSTABLE THERMOSTAT		KTR1100A	269°C THERMOSTAT KIT	<table border="1"> <thead> <tr> <th>Code</th> <th>Description</th> <th>Qty</th> <th>UOM</th> </tr> </thead> <tbody> <tr> <td>TR1100A0</td> <td>269°C 55.19052.80 ADJUSTABLE THERMOSTAT</td> <td>1.000</td> <td>PC</td> </tr> <tr> <td>VI1850A0</td> <td>TCB M4x6 SCREW</td> <td>2.000</td> <td>PC</td> </tr> </tbody> </table>	Code	Description	Qty	UOM	TR1100A0	269°C 55.19052.80 ADJUSTABLE THERMOSTAT	1.000	PC	VI1850A0	TCB M4x6 SCREW	2.000	PC												
Code	Description	Qty	UOM																										
TR1100A0	269°C 55.19052.80 ADJUSTABLE THERMOSTAT	1.000	PC																										
VI1850A0	TCB M4x6 SCREW	2.000	PC																										
VE1530A	GOLD THERMOMETER BLUE LIGHT COVER		KLP1012A	GOLDEN THERMOMETER BLUE LIGHT KIT	<table border="1"> <thead> <tr> <th>Code</th> <th>Description</th> <th>Qty</th> <th>UOM</th> </tr> </thead> <tbody> <tr> <td>VE1170A0</td> <td>D16 OPAQUE NICKEL ELLIPTICAL SUPPORT</td> <td>1.000</td> <td>PC</td> </tr> <tr> <td>VE1530A0</td> <td>GOLD THERMOMETE R BLUE LIGHT COVER</td> <td>1.000</td> <td>PC</td> </tr> <tr> <td>VE1535A1</td> <td>230V WHITE LED</td> <td>1.000</td> <td>PC</td> </tr> <tr> <td>VM1762A0</td> <td>INNER LAMP SUPPORT</td> <td>1.000</td> <td>PC</td> </tr> <tr> <td>VM2009A0</td> <td>D16 SILVER ELLIPTICAL SUPPORT</td> <td>1.000</td> <td>PC</td> </tr> </tbody> </table>	Code	Description	Qty	UOM	VE1170A0	D16 OPAQUE NICKEL ELLIPTICAL SUPPORT	1.000	PC	VE1530A0	GOLD THERMOMETE R BLUE LIGHT COVER	1.000	PC	VE1535A1	230V WHITE LED	1.000	PC	VM1762A0	INNER LAMP SUPPORT	1.000	PC	VM2009A0	D16 SILVER ELLIPTICAL SUPPORT	1.000	PC
					Code	Description	Qty	UOM																					
					VE1170A0	D16 OPAQUE NICKEL ELLIPTICAL SUPPORT	1.000	PC																					
					VE1530A0	GOLD THERMOMETE R BLUE LIGHT COVER	1.000	PC																					
					VE1535A1	230V WHITE LED	1.000	PC																					
					VM1762A0	INNER LAMP SUPPORT	1.000	PC																					
VM2009A0	D16 SILVER ELLIPTICAL SUPPORT	1.000	PC																										
<table border="1"> <thead> <tr> <th>Code</th> <th>Description</th> <th>Qty</th> <th>UOM</th> </tr> </thead> <tbody> <tr> <td>VE1535A1</td> <td>230V WHITE LED</td> <td>1.000</td> <td>PC</td> </tr> </tbody> </table>	Code	Description	Qty	UOM	VE1535A1	230V WHITE LED	1.000	PC																					
Code	Description	Qty	UOM																										
VE1535A1	230V WHITE LED	1.000	PC																										
<table border="1"> <thead> <tr> <th>Code</th> <th>Description</th> <th>Qty</th> <th>UOM</th> </tr> </thead> <tbody> <tr> <td>VE1170A0</td> <td>D16 OPAQUE NICKEL ELLIPTICAL SUPPORT</td> <td>1.000</td> <td>PC</td> </tr> <tr> <td>VE1535A1</td> <td>230V WHITE LED</td> <td>1.000</td> <td>PC</td> </tr> <tr> <td>VM1762A0</td> <td>INNER LAMP SUPPORT</td> <td>1.000</td> <td>PC</td> </tr> <tr> <td>VM1903A0</td> <td>GREEN PILOT WITH GOLD "CLOUD"</td> <td>1.000</td> <td>PC</td> </tr> </tbody> </table>	Code	Description	Qty	UOM	VE1170A0	D16 OPAQUE NICKEL ELLIPTICAL SUPPORT	1.000	PC	VE1535A1	230V WHITE LED	1.000	PC	VM1762A0	INNER LAMP SUPPORT	1.000	PC	VM1903A0	GREEN PILOT WITH GOLD "CLOUD"	1.000	PC									
Code	Description	Qty	UOM																										
VE1170A0	D16 OPAQUE NICKEL ELLIPTICAL SUPPORT	1.000	PC																										
VE1535A1	230V WHITE LED	1.000	PC																										
VM1762A0	INNER LAMP SUPPORT	1.000	PC																										
VM1903A0	GREEN PILOT WITH GOLD "CLOUD"	1.000	PC																										
<table border="1"> <thead> <tr> <th>Code</th> <th>Description</th> <th>Qty</th> <th>UOM</th> </tr> </thead> <tbody> <tr> <td>VE1535A1</td> <td>230V WHITE LED</td> <td>1.000</td> <td>PC</td> </tr> </tbody> </table>	Code	Description	Qty	UOM	VE1535A1	230V WHITE LED	1.000	PC																					
Code	Description	Qty	UOM																										
VE1535A1	230V WHITE LED	1.000	PC																										
<table border="1"> <thead> <tr> <th>Code</th> <th>Description</th> <th>Qty</th> <th>UOM</th> </tr> </thead> <tbody> <tr> <td>VE1170A0</td> <td>D16 OPAQUE NICKEL ELLIPTICAL SUPPORT</td> <td>1.000</td> <td>PC</td> </tr> <tr> <td>VE1535A1</td> <td>230V WHITE LED</td> <td>1.000</td> <td>PC</td> </tr> <tr> <td>VM1762A0</td> <td>INNER LAMP SUPPORT</td> <td>1.000</td> <td>PC</td> </tr> <tr> <td>VM1903A0</td> <td>GREEN PILOT WITH GOLD "CLOUD"</td> <td>1.000</td> <td>PC</td> </tr> </tbody> </table>	Code	Description	Qty	UOM	VE1170A0	D16 OPAQUE NICKEL ELLIPTICAL SUPPORT	1.000	PC	VE1535A1	230V WHITE LED	1.000	PC	VM1762A0	INNER LAMP SUPPORT	1.000	PC	VM1903A0	GREEN PILOT WITH GOLD "CLOUD"	1.000	PC									
Code	Description	Qty	UOM																										
VE1170A0	D16 OPAQUE NICKEL ELLIPTICAL SUPPORT	1.000	PC																										
VE1535A1	230V WHITE LED	1.000	PC																										
VM1762A0	INNER LAMP SUPPORT	1.000	PC																										
VM1903A0	GREEN PILOT WITH GOLD "CLOUD"	1.000	PC																										
<table border="1"> <thead> <tr> <th>Code</th> <th>Description</th> <th>Qty</th> <th>UOM</th> </tr> </thead> <tbody> <tr> <td>VE1535A1</td> <td>230V WHITE LED</td> <td>1.000</td> <td>PC</td> </tr> </tbody> </table>	Code	Description	Qty	UOM	VE1535A1	230V WHITE LED	1.000	PC																					
Code	Description	Qty	UOM																										
VE1535A1	230V WHITE LED	1.000	PC																										
VE1535A	230V WHITE LED		KVE1535A	230V WHITE LED LIGHT 1 PC KIT	<table border="1"> <thead> <tr> <th>Code</th> <th>Description</th> <th>Qty</th> <th>UOM</th> </tr> </thead> <tbody> <tr> <td>VE1535A1</td> <td>230V WHITE LED</td> <td>1.000</td> <td>PC</td> </tr> </tbody> </table>	Code	Description	Qty	UOM	VE1535A1	230V WHITE LED	1.000	PC																
Code	Description	Qty	UOM																										
VE1535A1	230V WHITE LED	1.000	PC																										
			KVE0105A	CLOUD LED LIGHT+COVER+SUP PORT KIT	<table border="1"> <thead> <tr> <th>Code</th> <th>Description</th> <th>Qty</th> <th>UOM</th> </tr> </thead> <tbody> <tr> <td>VE1170A0</td> <td>D16 OPAQUE NICKEL ELLIPTICAL SUPPORT</td> <td>1.000</td> <td>PC</td> </tr> <tr> <td>VE1535A1</td> <td>230V WHITE LED</td> <td>1.000</td> <td>PC</td> </tr> <tr> <td>VM1762A0</td> <td>INNER LAMP SUPPORT</td> <td>1.000</td> <td>PC</td> </tr> <tr> <td>VM1903A0</td> <td>GREEN PILOT WITH GOLD "CLOUD"</td> <td>1.000</td> <td>PC</td> </tr> </tbody> </table>	Code	Description	Qty	UOM	VE1170A0	D16 OPAQUE NICKEL ELLIPTICAL SUPPORT	1.000	PC	VE1535A1	230V WHITE LED	1.000	PC	VM1762A0	INNER LAMP SUPPORT	1.000	PC	VM1903A0	GREEN PILOT WITH GOLD "CLOUD"	1.000	PC				
Code	Description	Qty	UOM																										
VE1170A0	D16 OPAQUE NICKEL ELLIPTICAL SUPPORT	1.000	PC																										
VE1535A1	230V WHITE LED	1.000	PC																										
VM1762A0	INNER LAMP SUPPORT	1.000	PC																										
VM1903A0	GREEN PILOT WITH GOLD "CLOUD"	1.000	PC																										



COMPONENT			SPARE PART																						
Code	Description	Image	Code	Description	Kit components																				
VE1535A	230V WHITE LED		KVE0104A	NEUTRAL GREEN LIGHT KIT	<table border="1"> <thead> <tr> <th>Code</th> <th>Description</th> <th>Qty</th> <th>UOM</th> </tr> </thead> <tbody> <tr> <td>VE1170A0</td> <td>D16 OPAQUE NICKEL ELLIPTICAL SUPPORT</td> <td>1.000</td> <td>PC</td> </tr> <tr> <td>VE1535A1</td> <td>230V WHITE LED</td> <td>1.000</td> <td>PC</td> </tr> <tr> <td>VM1782A0</td> <td>INNER LAMP SUPPORT</td> <td>1.000</td> <td>PC</td> </tr> <tr> <td>VM1902A0</td> <td>NEUTRAL GREEN PLASTIC COVER FOR</td> <td>1.000</td> <td>PC</td> </tr> </tbody> </table>	Code	Description	Qty	UOM	VE1170A0	D16 OPAQUE NICKEL ELLIPTICAL SUPPORT	1.000	PC	VE1535A1	230V WHITE LED	1.000	PC	VM1782A0	INNER LAMP SUPPORT	1.000	PC	VM1902A0	NEUTRAL GREEN PLASTIC COVER FOR	1.000	PC
			Code	Description	Qty	UOM																			
			VE1170A0	D16 OPAQUE NICKEL ELLIPTICAL SUPPORT	1.000	PC																			
			VE1535A1	230V WHITE LED	1.000	PC																			
			VM1782A0	INNER LAMP SUPPORT	1.000	PC																			
			VM1902A0	NEUTRAL GREEN PLASTIC COVER FOR	1.000	PC																			
			KVE0102A	GOLDEN FLAME LIGHT COVER KIT	<table border="1"> <thead> <tr> <th>Code</th> <th>Description</th> <th>Qty</th> <th>UOM</th> </tr> </thead> <tbody> <tr> <td>VE1170A0</td> <td>D16 OPAQUE NICKEL ELLIPTICAL SUPPORT</td> <td>1.000</td> <td>PC</td> </tr> <tr> <td>VE1535A1</td> <td>230V WHITE LED</td> <td>1.000</td> <td>PC</td> </tr> <tr> <td>VM1782A0</td> <td>INNER LAMP SUPPORT</td> <td>1.000</td> <td>PC</td> </tr> <tr> <td>VM1787A0</td> <td>GREEN PILOT LIGHT W/ GOLD FLAME</td> <td>1.000</td> <td>PC</td> </tr> </tbody> </table>	Code	Description	Qty	UOM	VE1170A0	D16 OPAQUE NICKEL ELLIPTICAL SUPPORT	1.000	PC	VE1535A1	230V WHITE LED	1.000	PC	VM1782A0	INNER LAMP SUPPORT	1.000	PC	VM1787A0	GREEN PILOT LIGHT W/ GOLD FLAME	1.000	PC
			Code	Description	Qty	UOM																			
			VE1170A0	D16 OPAQUE NICKEL ELLIPTICAL SUPPORT	1.000	PC																			
			VE1535A1	230V WHITE LED	1.000	PC																			
			VM1782A0	INNER LAMP SUPPORT	1.000	PC																			
			VM1787A0	GREEN PILOT LIGHT W/ GOLD FLAME	1.000	PC																			
KVE0101A	SINUSOID LIGHT GREEN COVER KIT	<table border="1"> <thead> <tr> <th>Code</th> <th>Description</th> <th>Qty</th> <th>UOM</th> </tr> </thead> <tbody> <tr> <td>VE1170A0</td> <td>D16 OPAQUE NICKEL ELLIPTICAL SUPPORT</td> <td>1.000</td> <td>PC</td> </tr> <tr> <td>VE1535A1</td> <td>230V WHITE LED</td> <td>1.000</td> <td>PC</td> </tr> <tr> <td>VM1782A0</td> <td>INNER LAMP SUPPORT</td> <td>1.000</td> <td>PC</td> </tr> <tr> <td>VM1785A0</td> <td>GREEN PILOT WITH GOLD SINUSOIDE</td> <td>1.000</td> <td>PC</td> </tr> </tbody> </table>	Code	Description	Qty	UOM	VE1170A0	D16 OPAQUE NICKEL ELLIPTICAL SUPPORT	1.000	PC	VE1535A1	230V WHITE LED	1.000	PC	VM1782A0	INNER LAMP SUPPORT	1.000	PC	VM1785A0	GREEN PILOT WITH GOLD SINUSOIDE	1.000	PC			
Code	Description	Qty	UOM																						
VE1170A0	D16 OPAQUE NICKEL ELLIPTICAL SUPPORT	1.000	PC																						
VE1535A1	230V WHITE LED	1.000	PC																						
VM1782A0	INNER LAMP SUPPORT	1.000	PC																						
VM1785A0	GREEN PILOT WITH GOLD SINUSOIDE	1.000	PC																						
KVE0100A	THERMOMETER LIGHT COVER KIT	<table border="1"> <thead> <tr> <th>Code</th> <th>Description</th> <th>Qty</th> <th>UOM</th> </tr> </thead> <tbody> <tr> <td>VE1530A0</td> <td>GOLD THERMOMETE R BLUE LIGHT COVER</td> <td>1.000</td> <td>PC</td> </tr> <tr> <td>VE1535A1</td> <td>230V WHITE LED</td> <td>1.000</td> <td>PC</td> </tr> <tr> <td>VM1781A0</td> <td>D16 BLACK ELLIPTICAL SUPPORT</td> <td>1.000</td> <td>PC</td> </tr> <tr> <td>VM1782A0</td> <td>INNER LAMP SUPPORT</td> <td>1.000</td> <td>PC</td> </tr> </tbody> </table>	Code	Description	Qty	UOM	VE1530A0	GOLD THERMOMETE R BLUE LIGHT COVER	1.000	PC	VE1535A1	230V WHITE LED	1.000	PC	VM1781A0	D16 BLACK ELLIPTICAL SUPPORT	1.000	PC	VM1782A0	INNER LAMP SUPPORT	1.000	PC			
Code	Description	Qty	UOM																						
VE1530A0	GOLD THERMOMETE R BLUE LIGHT COVER	1.000	PC																						
VE1535A1	230V WHITE LED	1.000	PC																						
VM1781A0	D16 BLACK ELLIPTICAL SUPPORT	1.000	PC																						
VM1782A0	INNER LAMP SUPPORT	1.000	PC																						



COMPONENT			SPARE PART																																						
Code	Description	Image	Code	Description	Kit components																																				
VE1535A	230V WHITE LED		KVE0011A	SP KNOBS AND LIGHTS KIT	<table border="1"> <thead> <tr> <th>Code</th> <th>Description</th> <th>Qty</th> <th>UOM</th> </tr> </thead> <tbody> <tr> <td>MN1105A0</td> <td>120-400C XP THERMOSTAT KNOB</td> <td>1.000</td> <td>PC</td> </tr> <tr> <td>MN1110A0</td> <td>XP NEUTRAL INDEX DIAL</td> <td>1.000</td> <td>PC</td> </tr> <tr> <td>VE1530A0</td> <td>GOLD THERMOMETE R BLUE LIGHT COVER</td> <td>1.000</td> <td>PC</td> </tr> <tr> <td>VE1535A1</td> <td>230V WHITE LED</td> <td>1.000</td> <td>PC</td> </tr> <tr> <td>VE1561A0</td> <td>NA/NA BIPOLAR SWITCH</td> <td>1.000</td> <td>PC</td> </tr> <tr> <td>VM1761A0</td> <td>D16 BLACK ELLIPTICAL SUPPORT</td> <td>2.000</td> <td>PC</td> </tr> <tr> <td>VM1762A0</td> <td>INNER LAMP SUPPORT</td> <td>1.000</td> <td>PC</td> </tr> <tr> <td>VM1776A0</td> <td>"GOLD "0-1" MATT SILVER KEY"</td> <td>1.000</td> <td>PC</td> </tr> </tbody> </table>	Code	Description	Qty	UOM	MN1105A0	120-400C XP THERMOSTAT KNOB	1.000	PC	MN1110A0	XP NEUTRAL INDEX DIAL	1.000	PC	VE1530A0	GOLD THERMOMETE R BLUE LIGHT COVER	1.000	PC	VE1535A1	230V WHITE LED	1.000	PC	VE1561A0	NA/NA BIPOLAR SWITCH	1.000	PC	VM1761A0	D16 BLACK ELLIPTICAL SUPPORT	2.000	PC	VM1762A0	INNER LAMP SUPPORT	1.000	PC	VM1776A0	"GOLD "0-1" MATT SILVER KEY"	1.000	PC
			Code	Description	Qty	UOM																																			
			MN1105A0	120-400C XP THERMOSTAT KNOB	1.000	PC																																			
MN1110A0	XP NEUTRAL INDEX DIAL	1.000	PC																																						
VE1530A0	GOLD THERMOMETE R BLUE LIGHT COVER	1.000	PC																																						
VE1535A1	230V WHITE LED	1.000	PC																																						
VE1561A0	NA/NA BIPOLAR SWITCH	1.000	PC																																						
VM1761A0	D16 BLACK ELLIPTICAL SUPPORT	2.000	PC																																						
VM1762A0	INNER LAMP SUPPORT	1.000	PC																																						
VM1776A0	"GOLD "0-1" MATT SILVER KEY"	1.000	PC																																						
KVE0008A	XL PILOT BLUE LIGHTS KIT	<table border="1"> <thead> <tr> <th>Code</th> <th>Description</th> <th>Qty</th> <th>UOM</th> </tr> </thead> <tbody> <tr> <td>VE1170A0</td> <td>D16 OPAQUE NICKEL ELLIPTICAL SUPPORT</td> <td>3.000</td> <td>PC</td> </tr> <tr> <td>VE1530A0</td> <td>GOLD THERMOMETE R BLUE LIGHT COVER</td> <td>1.000</td> <td>PC</td> </tr> <tr> <td>VE1535A1</td> <td>230V WHITE LED</td> <td>1.000</td> <td>PC</td> </tr> <tr> <td>VE1561A0</td> <td>NA/NA BIPOLAR SWITCH</td> <td>1.000</td> <td>PC</td> </tr> <tr> <td>VE1562A0</td> <td>UNIPOLAR NA PUSH BUTTO</td> <td>1.000</td> <td>PC</td> </tr> <tr> <td>VM1762A0</td> <td>INNER LAMP SUPPORT</td> <td>1.000</td> <td>PC</td> </tr> <tr> <td>VM1775A0</td> <td>OPAQUE SILVER KEY WITH GOLD CLOUD</td> <td>1.000</td> <td>PC</td> </tr> <tr> <td>VM1776A0</td> <td>"GOLD "0-1" MATT SILVER KEY"</td> <td>1.000</td> <td>PC</td> </tr> </tbody> </table>	Code	Description	Qty	UOM	VE1170A0	D16 OPAQUE NICKEL ELLIPTICAL SUPPORT	3.000	PC	VE1530A0	GOLD THERMOMETE R BLUE LIGHT COVER	1.000	PC	VE1535A1	230V WHITE LED	1.000	PC	VE1561A0	NA/NA BIPOLAR SWITCH	1.000	PC	VE1562A0	UNIPOLAR NA PUSH BUTTO	1.000	PC	VM1762A0	INNER LAMP SUPPORT	1.000	PC	VM1775A0	OPAQUE SILVER KEY WITH GOLD CLOUD	1.000	PC	VM1776A0	"GOLD "0-1" MATT SILVER KEY"	1.000	PC			
Code	Description	Qty	UOM																																						
VE1170A0	D16 OPAQUE NICKEL ELLIPTICAL SUPPORT	3.000	PC																																						
VE1530A0	GOLD THERMOMETE R BLUE LIGHT COVER	1.000	PC																																						
VE1535A1	230V WHITE LED	1.000	PC																																						
VE1561A0	NA/NA BIPOLAR SWITCH	1.000	PC																																						
VE1562A0	UNIPOLAR NA PUSH BUTTO	1.000	PC																																						
VM1762A0	INNER LAMP SUPPORT	1.000	PC																																						
VM1775A0	OPAQUE SILVER KEY WITH GOLD CLOUD	1.000	PC																																						
VM1776A0	"GOLD "0-1" MATT SILVER KEY"	1.000	PC																																						
KVE0007A	XF-XG LED AND LED COVERS KIT	<table border="1"> <thead> <tr> <th>Code</th> <th>Description</th> <th>Qty</th> <th>UOM</th> </tr> </thead> <tbody> <tr> <td>VE1170A0</td> <td>D16 OPAQUE NICKEL ELLIPTICAL SUPPORT</td> <td>5.000</td> <td>PC</td> </tr> </tbody> </table>	Code	Description	Qty	UOM	VE1170A0	D16 OPAQUE NICKEL ELLIPTICAL SUPPORT	5.000	PC																															
Code	Description	Qty	UOM																																						
VE1170A0	D16 OPAQUE NICKEL ELLIPTICAL SUPPORT	5.000	PC																																						



COMPONENT			SPARE PART																																														
Code	Description	Image	Code	Description	Kit components																																												
VE1535A	230V WHITE LED		KVE0007A	XF-XG LED AND LED COVERS KIT	<table border="1"> <thead> <tr> <th>Code</th> <th>Description</th> <th>Qty</th> <th>UOM</th> </tr> </thead> <tbody> <tr> <td>VE1530A0</td> <td>GOLD THERMOMETE R BLUE LIGHT COVER</td> <td>1.000</td> <td>PC</td> </tr> <tr> <td>VE1535A1</td> <td>230V WHITE LED</td> <td>1.000</td> <td>PC</td> </tr> <tr> <td>VE1562A0</td> <td>UNIPOLAR NA PUSH BUTTO</td> <td>1.000</td> <td>PC</td> </tr> <tr> <td>VE1585A0</td> <td>BLUE LIGHT COVER GOLD SINUSOID</td> <td>1.000</td> <td>PC</td> </tr> <tr> <td>VM1762A0</td> <td>INNER LAMP SUPPORT</td> <td>4.000</td> <td>PC</td> </tr> <tr> <td>VM1767A0</td> <td>GREEN PILOT LIGHT W/ GOLD FLAME</td> <td>1.000</td> <td>PC</td> </tr> <tr> <td>VM1774A0</td> <td>SILVER OPAQUE KEY W/ GOLD FLAME</td> <td>1.000</td> <td>PC</td> </tr> <tr> <td>VM1775A0</td> <td>OPAQUE SILVER KEY WITH GOLD CLOUD</td> <td>1.000</td> <td>PC</td> </tr> <tr> <td>VM1902A0</td> <td>NEUTRAL GREEN PLASTIC COVER FOR</td> <td>1.000</td> <td>PC</td> </tr> <tr> <td>VM1903A0</td> <td>GREEN PILOT WITH GOLD "CLOUD"</td> <td>1.000</td> <td>PC</td> </tr> </tbody> </table>	Code	Description	Qty	UOM	VE1530A0	GOLD THERMOMETE R BLUE LIGHT COVER	1.000	PC	VE1535A1	230V WHITE LED	1.000	PC	VE1562A0	UNIPOLAR NA PUSH BUTTO	1.000	PC	VE1585A0	BLUE LIGHT COVER GOLD SINUSOID	1.000	PC	VM1762A0	INNER LAMP SUPPORT	4.000	PC	VM1767A0	GREEN PILOT LIGHT W/ GOLD FLAME	1.000	PC	VM1774A0	SILVER OPAQUE KEY W/ GOLD FLAME	1.000	PC	VM1775A0	OPAQUE SILVER KEY WITH GOLD CLOUD	1.000	PC	VM1902A0	NEUTRAL GREEN PLASTIC COVER FOR	1.000	PC	VM1903A0	GREEN PILOT WITH GOLD "CLOUD"	1.000	PC
			Code	Description	Qty	UOM																																											
			VE1530A0	GOLD THERMOMETE R BLUE LIGHT COVER	1.000	PC																																											
VE1535A1	230V WHITE LED	1.000	PC																																														
VE1562A0	UNIPOLAR NA PUSH BUTTO	1.000	PC																																														
VE1585A0	BLUE LIGHT COVER GOLD SINUSOID	1.000	PC																																														
VM1762A0	INNER LAMP SUPPORT	4.000	PC																																														
VM1767A0	GREEN PILOT LIGHT W/ GOLD FLAME	1.000	PC																																														
VM1774A0	SILVER OPAQUE KEY W/ GOLD FLAME	1.000	PC																																														
VM1775A0	OPAQUE SILVER KEY WITH GOLD CLOUD	1.000	PC																																														
VM1902A0	NEUTRAL GREEN PLASTIC COVER FOR	1.000	PC																																														
VM1903A0	GREEN PILOT WITH GOLD "CLOUD"	1.000	PC																																														
KLP1014A	SINUSOID LED LIGHT+COVER+SUPPORT KIT	<table border="1"> <thead> <tr> <th>Code</th> <th>Description</th> <th>Qty</th> <th>UOM</th> </tr> </thead> <tbody> <tr> <td>VE1170A0</td> <td>D16 OPAQUE NICKEL ELLIPTICAL SUPPORT</td> <td>2.000</td> <td>PC</td> </tr> <tr> <td>VE1535A1</td> <td>230V WHITE LED</td> <td>2.000</td> <td>PC</td> </tr> <tr> <td>VE1585A0</td> <td>BLUE LIGHT COVER GOLD SINUSOID</td> <td>2.000</td> <td>PC</td> </tr> <tr> <td>VM1762A0</td> <td>INNER LAMP SUPPORT</td> <td>2.000</td> <td>PC</td> </tr> <tr> <td>VM2009A0</td> <td>D16 SILVER ELLIPTICAL SUPPORT</td> <td>1.000</td> <td>PC</td> </tr> </tbody> </table>	Code	Description	Qty	UOM	VE1170A0	D16 OPAQUE NICKEL ELLIPTICAL SUPPORT	2.000	PC	VE1535A1	230V WHITE LED	2.000	PC	VE1585A0	BLUE LIGHT COVER GOLD SINUSOID	2.000	PC	VM1762A0	INNER LAMP SUPPORT	2.000	PC	VM2009A0	D16 SILVER ELLIPTICAL SUPPORT	1.000	PC																							
Code	Description	Qty	UOM																																														
VE1170A0	D16 OPAQUE NICKEL ELLIPTICAL SUPPORT	2.000	PC																																														
VE1535A1	230V WHITE LED	2.000	PC																																														
VE1585A0	BLUE LIGHT COVER GOLD SINUSOID	2.000	PC																																														
VM1762A0	INNER LAMP SUPPORT	2.000	PC																																														
VM2009A0	D16 SILVER ELLIPTICAL SUPPORT	1.000	PC																																														
KLP1012A	GOLDEN THERMOMETER BLUE LIGHT KIT	<table border="1"> <thead> <tr> <th>Code</th> <th>Description</th> <th>Qty</th> <th>UOM</th> </tr> </thead> <tbody> <tr> <td>VE1170A0</td> <td>D16 OPAQUE NICKEL ELLIPTICAL SUPPORT</td> <td>1.000</td> <td>PC</td> </tr> </tbody> </table>	Code	Description	Qty	UOM	VE1170A0	D16 OPAQUE NICKEL ELLIPTICAL SUPPORT	1.000	PC																																							
Code	Description	Qty	UOM																																														
VE1170A0	D16 OPAQUE NICKEL ELLIPTICAL SUPPORT	1.000	PC																																														

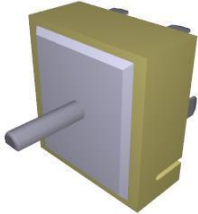
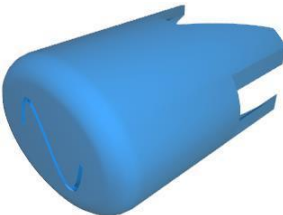

COMPONENT			SPARE PART																										
Code	Description	Image	Code	Description	Kit components																								
VE1535A	230V WHITE LED		KLP1012A	GOLDEN THERMOMETER BLUE LIGHT KIT	<table border="1"> <thead> <tr> <th>Code</th> <th>Description</th> <th>Qty</th> <th>UOM</th> </tr> </thead> <tbody> <tr> <td>VE1530A0</td> <td>GOLD THERMOMETE R BLUE LIGHT COVER</td> <td>1.000</td> <td>PC</td> </tr> <tr> <td>VE1535A1</td> <td>230V WHITE LED</td> <td>1.000</td> <td>PC</td> </tr> <tr> <td>VM1762A0</td> <td>INNER LAMP SUPPORT</td> <td>1.000</td> <td>PC</td> </tr> <tr> <td>VM2009A0</td> <td>D16 SILVER ELLIPTICAL SUPPORT</td> <td>1.000</td> <td>PC</td> </tr> </tbody> </table>	Code	Description	Qty	UOM	VE1530A0	GOLD THERMOMETE R BLUE LIGHT COVER	1.000	PC	VE1535A1	230V WHITE LED	1.000	PC	VM1762A0	INNER LAMP SUPPORT	1.000	PC	VM2009A0	D16 SILVER ELLIPTICAL SUPPORT	1.000	PC				
			Code	Description	Qty	UOM																							
VE1530A0	GOLD THERMOMETE R BLUE LIGHT COVER	1.000	PC																										
VE1535A1	230V WHITE LED	1.000	PC																										
VM1762A0	INNER LAMP SUPPORT	1.000	PC																										
VM2009A0	D16 SILVER ELLIPTICAL SUPPORT	1.000	PC																										
KLP1010A	THERMOSTAT GREEN LIGHT KIT	<table border="1"> <thead> <tr> <th>Code</th> <th>Description</th> <th>Qty</th> <th>UOM</th> </tr> </thead> <tbody> <tr> <td>VE1170A0</td> <td>D16 OPAQUE NICKEL ELLIPTICAL SUPPORT</td> <td>1.000</td> <td>PC</td> </tr> <tr> <td>VE1535A1</td> <td>230V WHITE LED</td> <td>1.000</td> <td>PC</td> </tr> <tr> <td>VM1762A0</td> <td>INNER LAMP SUPPORT</td> <td>1.000</td> <td>PC</td> </tr> <tr> <td>VM1764A0</td> <td>GREEN PILOT WITH GOLD THERMOMETE</td> <td>1.000</td> <td>PC</td> </tr> </tbody> </table>	Code	Description	Qty	UOM	VE1170A0	D16 OPAQUE NICKEL ELLIPTICAL SUPPORT	1.000	PC	VE1535A1	230V WHITE LED	1.000	PC	VM1762A0	INNER LAMP SUPPORT	1.000	PC	VM1764A0	GREEN PILOT WITH GOLD THERMOMETE	1.000	PC							
Code	Description	Qty	UOM																										
VE1170A0	D16 OPAQUE NICKEL ELLIPTICAL SUPPORT	1.000	PC																										
VE1535A1	230V WHITE LED	1.000	PC																										
VM1762A0	INNER LAMP SUPPORT	1.000	PC																										
VM1764A0	GREEN PILOT WITH GOLD THERMOMETE	1.000	PC																										
VE1556A	THERMAL SWITCH 240V		KVE1556A	ENERGY REGULATOR KIT	<table border="1"> <thead> <tr> <th>Code</th> <th>Description</th> <th>Qty</th> <th>UOM</th> </tr> </thead> <tbody> <tr> <td>VE1556A0</td> <td>THERMAL SWITCH 240V</td> <td>1.000</td> <td>PC</td> </tr> <tr> <td>VH1850A0</td> <td>TCB M4x6 SCREW</td> <td>2.000</td> <td>PC</td> </tr> </tbody> </table>	Code	Description	Qty	UOM	VE1556A0	THERMAL SWITCH 240V	1.000	PC	VH1850A0	TCB M4x6 SCREW	2.000	PC												
Code	Description	Qty	UOM																										
VE1556A0	THERMAL SWITCH 240V	1.000	PC																										
VH1850A0	TCB M4x6 SCREW	2.000	PC																										
VE1585A	BLUE LIGHT COVER GOLD SINUSOID		KLP1014A	SINUSOID LED LIGHT+COVER+SUP PORT KIT	<table border="1"> <thead> <tr> <th>Code</th> <th>Description</th> <th>Qty</th> <th>UOM</th> </tr> </thead> <tbody> <tr> <td>VE1170A0</td> <td>D16 OPAQUE NICKEL ELLIPTICAL SUPPORT</td> <td>2.000</td> <td>PC</td> </tr> <tr> <td>VE1535A1</td> <td>230V WHITE LED</td> <td>2.000</td> <td>PC</td> </tr> <tr> <td>VE1585A0</td> <td>BLUE LIGHT COVER GOLD SINUSOID</td> <td>2.000</td> <td>PC</td> </tr> <tr> <td>VM1762A0</td> <td>INNER LAMP SUPPORT</td> <td>2.000</td> <td>PC</td> </tr> <tr> <td>VM2009A0</td> <td>D16 SILVER ELLIPTICAL SUPPORT</td> <td>1.000</td> <td>PC</td> </tr> </tbody> </table>	Code	Description	Qty	UOM	VE1170A0	D16 OPAQUE NICKEL ELLIPTICAL SUPPORT	2.000	PC	VE1535A1	230V WHITE LED	2.000	PC	VE1585A0	BLUE LIGHT COVER GOLD SINUSOID	2.000	PC	VM1762A0	INNER LAMP SUPPORT	2.000	PC	VM2009A0	D16 SILVER ELLIPTICAL SUPPORT	1.000	PC
					Code	Description	Qty	UOM																					
					VE1170A0	D16 OPAQUE NICKEL ELLIPTICAL SUPPORT	2.000	PC																					
					VE1535A1	230V WHITE LED	2.000	PC																					
					VE1585A0	BLUE LIGHT COVER GOLD SINUSOID	2.000	PC																					
VM1762A0	INNER LAMP SUPPORT	2.000	PC																										
VM2009A0	D16 SILVER ELLIPTICAL SUPPORT	1.000	PC																										







COMPONENT			SPARE PART																														
Code	Description	Image	Code	Description	Kit components																												
VM1762A	INNER LAMP SUPPORT		KVM1762A	LAMP INTERNAL SUPPORT KIT	<table border="1"> <thead> <tr> <th>Code</th> <th>Description</th> <th>Qty</th> <th>UOM</th> </tr> </thead> <tbody> <tr> <td>VM1762A0</td> <td>INNER LAMP SUPPORT</td> <td>1.000</td> <td>PC</td> </tr> </tbody> </table>	Code	Description	Qty	UOM	VM1762A0	INNER LAMP SUPPORT	1.000	PC																				
Code	Description	Qty	UOM																														
VM1762A0	INNER LAMP SUPPORT	1.000	PC																														
VM2007A	FAN SPEED SILVER BUTTON		KVM2007A	FAN SPEED BUTTON KIT	<table border="1"> <thead> <tr> <th>Code</th> <th>Description</th> <th>Qty</th> <th>UOM</th> </tr> </thead> <tbody> <tr> <td>VM2007A0</td> <td>FAN SPEED SILVER BUTTON</td> <td>1.000</td> <td>PC</td> </tr> </tbody> </table>	Code	Description	Qty	UOM	VM2007A0	FAN SPEED SILVER BUTTON	1.000	PC																				
Code	Description	Qty	UOM																														
VM2007A0	FAN SPEED SILVER BUTTON	1.000	PC																														
VM2009A	D16 SILVER ELLIPTICAL SUPPORT		KVM2009A KVM1019B	D16 SILVER ELLIPTICAL SUPPORT KIT MANUAL PROVER CONTROL BOARD KIT	<table border="1"> <thead> <tr> <th>Code</th> <th>Description</th> <th>Qty</th> <th>UOM</th> </tr> </thead> <tbody> <tr> <td>VM2009A0</td> <td>D16 SILVER ELLIPTICAL SUPPORT</td> <td>1.000</td> <td>PC</td> </tr> </tbody> </table> <table border="1"> <thead> <tr> <th>Code</th> <th>Description</th> <th>Qty</th> <th>UOM</th> </tr> </thead> <tbody> <tr> <td>MS1018B0</td> <td>MANUAL PROOFER CONTROL BOARD STICKER</td> <td>1.000</td> <td>PC</td> </tr> <tr> <td>MS1018C0</td> <td>MANUAL PROVER FRONT COVER (° C)</td> <td>1.000</td> <td>PC</td> </tr> <tr> <td>VM1019B0</td> <td>MANUAL PROOVER PLASTIC CONTROL PANEL</td> <td>1.000</td> <td>PC</td> </tr> <tr> <td>VM2009A0</td> <td>D16 SILVER ELLIPTICAL SUPPORT</td> <td>3.000</td> <td>PC</td> </tr> </tbody> </table>	Code	Description	Qty	UOM	VM2009A0	D16 SILVER ELLIPTICAL SUPPORT	1.000	PC	Code	Description	Qty	UOM	MS1018B0	MANUAL PROOFER CONTROL BOARD STICKER	1.000	PC	MS1018C0	MANUAL PROVER FRONT COVER (° C)	1.000	PC	VM1019B0	MANUAL PROOVER PLASTIC CONTROL PANEL	1.000	PC	VM2009A0	D16 SILVER ELLIPTICAL SUPPORT	3.000	PC
Code	Description	Qty	UOM																														
VM2009A0	D16 SILVER ELLIPTICAL SUPPORT	1.000	PC																														
Code	Description	Qty	UOM																														
MS1018B0	MANUAL PROOFER CONTROL BOARD STICKER	1.000	PC																														
MS1018C0	MANUAL PROVER FRONT COVER (° C)	1.000	PC																														
VM1019B0	MANUAL PROOVER PLASTIC CONTROL PANEL	1.000	PC																														
VM2009A0	D16 SILVER ELLIPTICAL SUPPORT	3.000	PC																														
VM2203A	CHEFLUX MANUAL CONTROL BOARD		KVM2203A	CHEFLUX XV393 COMPLETE CONTROL BOARD KIT	<table border="1"> <thead> <tr> <th>Code</th> <th>Description</th> <th>Qty</th> <th>UOM</th> </tr> </thead> <tbody> <tr> <td>VE1530A0</td> <td>GOLD THERMOMETE R BLUE LIGHT COVER</td> <td>1.000</td> <td>PC</td> </tr> <tr> <td>VE1535A1</td> <td>230V WHITE LED</td> <td>2.000</td> <td>PC</td> </tr> <tr> <td>VE1561A0</td> <td>NA/NA BIPOLAR SWITCH</td> <td>1.000</td> <td>PC</td> </tr> </tbody> </table>	Code	Description	Qty	UOM	VE1530A0	GOLD THERMOMETE R BLUE LIGHT COVER	1.000	PC	VE1535A1	230V WHITE LED	2.000	PC	VE1561A0	NA/NA BIPOLAR SWITCH	1.000	PC												
Code	Description	Qty	UOM																														
VE1530A0	GOLD THERMOMETE R BLUE LIGHT COVER	1.000	PC																														
VE1535A1	230V WHITE LED	2.000	PC																														
VE1561A0	NA/NA BIPOLAR SWITCH	1.000	PC																														



COMPONENT			SPARE PART																										
Code	Description	Image	Code	Description	Kit components																								
VM2203A	CHEFLUX MANUAL CONTROL BOARD		KVM2203A	CHEFLUX XV393 COMPLETE CONTROL BOARD KIT	<table border="1"> <thead> <tr> <th>Code</th> <th>Description</th> <th>Qty</th> <th>UOM</th> </tr> </thead> <tbody> <tr> <td>VE1585A0</td> <td>BLUE LIGHT COVER GOLD SINUSOID</td> <td>1.000</td> <td>PC</td> </tr> <tr> <td>VM1762A0</td> <td>INNER LAMP SUPPORT</td> <td>2.000</td> <td>PC</td> </tr> <tr> <td>VM2007A0</td> <td>FAN SPEED SILVER BUTTON</td> <td>1.000</td> <td>PC</td> </tr> <tr> <td>VM2009A0</td> <td>D16 SILVER ELLIPTICAL SUPPORT</td> <td>3.000</td> <td>PC</td> </tr> <tr> <td>VM2203A0</td> <td>CHEFLUX MANUAL CONTROL BOARD</td> <td>1.000</td> <td>PC</td> </tr> </tbody> </table>	Code	Description	Qty	UOM	VE1585A0	BLUE LIGHT COVER GOLD SINUSOID	1.000	PC	VM1762A0	INNER LAMP SUPPORT	2.000	PC	VM2007A0	FAN SPEED SILVER BUTTON	1.000	PC	VM2009A0	D16 SILVER ELLIPTICAL SUPPORT	3.000	PC	VM2203A0	CHEFLUX MANUAL CONTROL BOARD	1.000	PC
Code	Description	Qty	UOM																										
VE1585A0	BLUE LIGHT COVER GOLD SINUSOID	1.000	PC																										
VM1762A0	INNER LAMP SUPPORT	2.000	PC																										
VM2007A0	FAN SPEED SILVER BUTTON	1.000	PC																										
VM2009A0	D16 SILVER ELLIPTICAL SUPPORT	3.000	PC																										
VM2203A0	CHEFLUX MANUAL CONTROL BOARD	1.000	PC																										
EL1195A	ELBOW UNION Ø8F-Ø8M		KEL1195A	D8F-D8M JG ELBOW FITTING 10 PCS KIT	<table border="1"> <thead> <tr> <th>Code</th> <th>Description</th> <th>Qty</th> <th>UOM</th> </tr> </thead> <tbody> <tr> <td>EL1195A0</td> <td>ELBOW UNION Ø8F-Ø8M</td> <td>10.000</td> <td>PC</td> </tr> </tbody> </table>	Code	Description	Qty	UOM	EL1195A0	ELBOW UNION Ø8F-Ø8M	10.000	PC																
Code	Description	Qty	UOM																										
EL1195A0	ELBOW UNION Ø8F-Ø8M	10.000	PC																										
GN1275A	XBC/XVC BLACK CHIMNEY SEALING		KGN1275A	BLACK SILICON CHIMNEY SEALING 4 PCS KIT	<table border="1"> <thead> <tr> <th>Code</th> <th>Description</th> <th>Qty</th> <th>UOM</th> </tr> </thead> <tbody> <tr> <td>GN1275A0</td> <td>XBC/XVC BLACK CHIMNEY SEALING</td> <td>4.000</td> <td>PC</td> </tr> </tbody> </table>	Code	Description	Qty	UOM	GN1275A0	XBC/XVC BLACK CHIMNEY SEALING	4.000	PC																
Code	Description	Qty	UOM																										
GN1275A0	XBC/XVC BLACK CHIMNEY SEALING	4.000	PC																										
RC1002A	JG 10M-8F TERMINAL REDUCTION FITTIN		KRC1002A	JG Ø10M-Ø8F REDUCING SPIGOT 10 PCS KIT	<table border="1"> <thead> <tr> <th>Code</th> <th>Description</th> <th>Qty</th> <th>UOM</th> </tr> </thead> <tbody> <tr> <td>RC1002A0</td> <td>JG 10M-8F TERMINAL REDUCTION FITTING</td> <td>10.000</td> <td>PC</td> </tr> </tbody> </table>	Code	Description	Qty	UOM	RC1002A0	JG 10M-8F TERMINAL REDUCTION FITTING	10.000	PC																
Code	Description	Qty	UOM																										
RC1002A0	JG 10M-8F TERMINAL REDUCTION FITTING	10.000	PC																										



COMPONENT			SPARE PART																						
Code	Description	Image	Code	Description	Kit components																				
TB2823A	TB1815A0-D8 WATER PIPE XV393 0,5M		TB2823A0	TB1815A0-D8 WATER PIPE XV393 0,5M																					
VI1081A	M6X25 STAINLESS STEEL SCREW		KVI1081A	10PCS. M6x25 ST.STEEL SCREW KI	<table border="1"> <thead> <tr> <th>Code</th> <th>Description</th> <th>Qty</th> <th>UOM</th> </tr> </thead> <tbody> <tr> <td>VI1081A0</td> <td>M6X25 STAINLESS STEEL SCREW</td> <td>10.000</td> <td>PC</td> </tr> </tbody> </table>	Code	Description	Qty	UOM	VI1081A0	M6X25 STAINLESS STEEL SCREW	10.000	PC												
Code	Description	Qty	UOM																						
VI1081A0	M6X25 STAINLESS STEEL SCREW	10.000	PC																						
VM1165B	CT BT DOOR UPPER BRACKET		KVM1165B	CT BT CL BL DOOR UPPER BRACKET KI	<table border="1"> <thead> <tr> <th>Code</th> <th>Description</th> <th>Qty</th> <th>UOM</th> </tr> </thead> <tbody> <tr> <td>VM1165B0</td> <td>CT BT DOOR UPPER BRACKET</td> <td>1.000</td> <td>PC</td> </tr> </tbody> </table>	Code	Description	Qty	UOM	VM1165B0	CT BT DOOR UPPER BRACKET	1.000	PC												
Code	Description	Qty	UOM																						
VM1165B0	CT BT DOOR UPPER BRACKET	1.000	PC																						
VM1166A	CAP FOR DOOR UPPER STIRRUP XVC204/304/5		KVM1166A	DOOR UPPER BRACKET COVER KI	<table border="1"> <thead> <tr> <th>Code</th> <th>Description</th> <th>Qty</th> <th>UOM</th> </tr> </thead> <tbody> <tr> <td>VM1166A0</td> <td>CAP FOR DOOR UPPER STIRRUP XVC204/304/5</td> <td>1.000</td> <td>PC</td> </tr> </tbody> </table>	Code	Description	Qty	UOM	VM1166A0	CAP FOR DOOR UPPER STIRRUP XVC204/304/5	1.000	PC												
Code	Description	Qty	UOM																						
VM1166A0	CAP FOR DOOR UPPER STIRRUP XVC204/304/5	1.000	PC																						
VM1190A	CT BT RIGHT DOOR SPRING LATCH		KVM1190A	CHEFTOP/BAKERTO P DOOR RIGHT LATCH KIT	<table border="1"> <thead> <tr> <th>Code</th> <th>Description</th> <th>Qty</th> <th>UOM</th> </tr> </thead> <tbody> <tr> <td>VI1074A0</td> <td>4X16 SCREW FOR PLASTIC</td> <td>2.000</td> <td>PC</td> </tr> <tr> <td>VI1220A1</td> <td>4,2x12 TCB SELF-TAPPIN G SCREW</td> <td>2.000</td> <td>PC</td> </tr> <tr> <td>VM1460A0</td> <td>XBC/XVC RIGHT DOOR LATCH CAP</td> <td>1.000</td> <td>PC</td> </tr> <tr> <td>VP1530A0</td> <td>BT CT RIGHT HANDLE LATC</td> <td>1.000</td> <td>PC</td> </tr> </tbody> </table>	Code	Description	Qty	UOM	VI1074A0	4X16 SCREW FOR PLASTIC	2.000	PC	VI1220A1	4,2x12 TCB SELF-TAPPIN G SCREW	2.000	PC	VM1460A0	XBC/XVC RIGHT DOOR LATCH CAP	1.000	PC	VP1530A0	BT CT RIGHT HANDLE LATC	1.000	PC
Code	Description	Qty	UOM																						
VI1074A0	4X16 SCREW FOR PLASTIC	2.000	PC																						
VI1220A1	4,2x12 TCB SELF-TAPPIN G SCREW	2.000	PC																						
VM1460A0	XBC/XVC RIGHT DOOR LATCH CAP	1.000	PC																						
VP1530A0	BT CT RIGHT HANDLE LATC	1.000	PC																						





COMPONENT			SPARE PART																						
Code	Description	Image	Code	Description	Kit components																				
VM1191A	CT BT LEFT DOOR SPRING LATCH		KVM1191A	CHEFTOP/BAKERTO P DOOR LEFT LATCH KIT	<table border="1"> <thead> <tr> <th>Code</th> <th>Description</th> <th>Qty</th> <th>UOM</th> </tr> </thead> <tbody> <tr> <td>VI1074A0</td> <td>4X16 SCREW FOR PLASTIC</td> <td>2.000</td> <td>PC</td> </tr> <tr> <td>VI1220A1</td> <td>4,2x12 TCB SELF-TAPPIN G SCREW</td> <td>2.000</td> <td>PC</td> </tr> <tr> <td>VM1460A0</td> <td>XBC/XVC RIGHT DOOR LATCH CAP</td> <td>1.000</td> <td>PC</td> </tr> <tr> <td>VP1531A0</td> <td>BT CT LEFT HANDLE LATC</td> <td>1.000</td> <td>PC</td> </tr> </tbody> </table>	Code	Description	Qty	UOM	VI1074A0	4X16 SCREW FOR PLASTIC	2.000	PC	VI1220A1	4,2x12 TCB SELF-TAPPIN G SCREW	2.000	PC	VM1460A0	XBC/XVC RIGHT DOOR LATCH CAP	1.000	PC	VP1531A0	BT CT LEFT HANDLE LATC	1.000	PC
					Code	Description	Qty	UOM																	
					VI1074A0	4X16 SCREW FOR PLASTIC	2.000	PC																	
					VI1220A1	4,2x12 TCB SELF-TAPPIN G SCREW	2.000	PC																	
VM1460A0	XBC/XVC RIGHT DOOR LATCH CAP	1.000	PC																						
VP1531A0	BT CT LEFT HANDLE LATC	1.000	PC																						
<table border="1"> <thead> <tr> <th>Code</th> <th>Description</th> <th>Qty</th> <th>UOM</th> </tr> </thead> <tbody> <tr> <td>VI1074A0</td> <td>4X16 SCREW FOR PLASTIC</td> <td>2.000</td> <td>PC</td> </tr> <tr> <td>VI1220A1</td> <td>4,2x12 TCB SELF-TAPPIN G SCREW</td> <td>2.000</td> <td>PC</td> </tr> <tr> <td>VM1460A0</td> <td>XBC/XVC RIGHT DOOR LATCH CAP</td> <td>1.000</td> <td>PC</td> </tr> <tr> <td>VP1531A0</td> <td>BT CT LEFT HANDLE LATC</td> <td>1.000</td> <td>PC</td> </tr> </tbody> </table>	Code	Description	Qty	UOM	VI1074A0	4X16 SCREW FOR PLASTIC	2.000	PC	VI1220A1	4,2x12 TCB SELF-TAPPIN G SCREW	2.000	PC	VM1460A0	XBC/XVC RIGHT DOOR LATCH CAP	1.000	PC	VP1531A0	BT CT LEFT HANDLE LATC	1.000	PC					
Code	Description	Qty	UOM																						
VI1074A0	4X16 SCREW FOR PLASTIC	2.000	PC																						
VI1220A1	4,2x12 TCB SELF-TAPPIN G SCREW	2.000	PC																						
VM1460A0	XBC/XVC RIGHT DOOR LATCH CAP	1.000	PC																						
VP1531A0	BT CT LEFT HANDLE LATC	1.000	PC																						
<table border="1"> <thead> <tr> <th>Code</th> <th>Description</th> <th>Qty</th> <th>UOM</th> </tr> </thead> <tbody> <tr> <td>VI1074A0</td> <td>4X16 SCREW FOR PLASTIC</td> <td>2.000</td> <td>PC</td> </tr> <tr> <td>VI1220A1</td> <td>4,2x12 TCB SELF-TAPPIN G SCREW</td> <td>2.000</td> <td>PC</td> </tr> <tr> <td>VM1460A0</td> <td>XBC/XVC RIGHT DOOR LATCH CAP</td> <td>1.000</td> <td>PC</td> </tr> <tr> <td>VP1531A0</td> <td>BT CT LEFT HANDLE LATC</td> <td>1.000</td> <td>PC</td> </tr> </tbody> </table>	Code	Description	Qty	UOM	VI1074A0	4X16 SCREW FOR PLASTIC	2.000	PC	VI1220A1	4,2x12 TCB SELF-TAPPIN G SCREW	2.000	PC	VM1460A0	XBC/XVC RIGHT DOOR LATCH CAP	1.000	PC	VP1531A0	BT CT LEFT HANDLE LATC	1.000	PC					
Code	Description	Qty	UOM																						
VI1074A0	4X16 SCREW FOR PLASTIC	2.000	PC																						
VI1220A1	4,2x12 TCB SELF-TAPPIN G SCREW	2.000	PC																						
VM1460A0	XBC/XVC RIGHT DOOR LATCH CAP	1.000	PC																						
VP1531A0	BT CT LEFT HANDLE LATC	1.000	PC																						
<table border="1"> <thead> <tr> <th>Code</th> <th>Description</th> <th>Qty</th> <th>UOM</th> </tr> </thead> <tbody> <tr> <td>VI1074A0</td> <td>4X16 SCREW FOR PLASTIC</td> <td>2.000</td> <td>PC</td> </tr> <tr> <td>VI1220A1</td> <td>4,2x12 TCB SELF-TAPPIN G SCREW</td> <td>2.000</td> <td>PC</td> </tr> <tr> <td>VM1460A0</td> <td>XBC/XVC RIGHT DOOR LATCH CAP</td> <td>1.000</td> <td>PC</td> </tr> <tr> <td>VP1531A0</td> <td>BT CT LEFT HANDLE LATC</td> <td>1.000</td> <td>PC</td> </tr> </tbody> </table>	Code	Description	Qty	UOM	VI1074A0	4X16 SCREW FOR PLASTIC	2.000	PC	VI1220A1	4,2x12 TCB SELF-TAPPIN G SCREW	2.000	PC	VM1460A0	XBC/XVC RIGHT DOOR LATCH CAP	1.000	PC	VP1531A0	BT CT LEFT HANDLE LATC	1.000	PC					
Code	Description	Qty	UOM																						
VI1074A0	4X16 SCREW FOR PLASTIC	2.000	PC																						
VI1220A1	4,2x12 TCB SELF-TAPPIN G SCREW	2.000	PC																						
VM1460A0	XBC/XVC RIGHT DOOR LATCH CAP	1.000	PC																						
VP1531A0	BT CT LEFT HANDLE LATC	1.000	PC																						
VM1192A	CT BT DOOR SPRING LATCH BACK COVER		KVM1191A	CHEFTOP/BAKERTO P DOOR LEFT LATCH KIT	<table border="1"> <thead> <tr> <th>Code</th> <th>Description</th> <th>Qty</th> <th>UOM</th> </tr> </thead> <tbody> <tr> <td>VI1074A0</td> <td>4X16 SCREW FOR PLASTIC</td> <td>2.000</td> <td>PC</td> </tr> <tr> <td>VI1220A1</td> <td>4,2x12 TCB SELF-TAPPIN G SCREW</td> <td>2.000</td> <td>PC</td> </tr> <tr> <td>VM1460A0</td> <td>XBC/XVC RIGHT DOOR LATCH CAP</td> <td>1.000</td> <td>PC</td> </tr> <tr> <td>VP1531A0</td> <td>BT CT LEFT HANDLE LATC</td> <td>1.000</td> <td>PC</td> </tr> </tbody> </table>	Code	Description	Qty	UOM	VI1074A0	4X16 SCREW FOR PLASTIC	2.000	PC	VI1220A1	4,2x12 TCB SELF-TAPPIN G SCREW	2.000	PC	VM1460A0	XBC/XVC RIGHT DOOR LATCH CAP	1.000	PC	VP1531A0	BT CT LEFT HANDLE LATC	1.000	PC
					Code	Description	Qty	UOM																	
					VI1074A0	4X16 SCREW FOR PLASTIC	2.000	PC																	
					VI1220A1	4,2x12 TCB SELF-TAPPIN G SCREW	2.000	PC																	
VM1460A0	XBC/XVC RIGHT DOOR LATCH CAP	1.000	PC																						
VP1531A0	BT CT LEFT HANDLE LATC	1.000	PC																						
<table border="1"> <thead> <tr> <th>Code</th> <th>Description</th> <th>Qty</th> <th>UOM</th> </tr> </thead> <tbody> <tr> <td>VI1074A0</td> <td>4X16 SCREW FOR PLASTIC</td> <td>2.000</td> <td>PC</td> </tr> <tr> <td>VI1220A1</td> <td>4,2x12 TCB SELF-TAPPIN G SCREW</td> <td>2.000</td> <td>PC</td> </tr> <tr> <td>VM1460A0</td> <td>XBC/XVC RIGHT DOOR LATCH CAP</td> <td>1.000</td> <td>PC</td> </tr> <tr> <td>VP1531A0</td> <td>BT CT LEFT HANDLE LATC</td> <td>1.000</td> <td>PC</td> </tr> </tbody> </table>	Code	Description	Qty	UOM	VI1074A0	4X16 SCREW FOR PLASTIC	2.000	PC	VI1220A1	4,2x12 TCB SELF-TAPPIN G SCREW	2.000	PC	VM1460A0	XBC/XVC RIGHT DOOR LATCH CAP	1.000	PC	VP1531A0	BT CT LEFT HANDLE LATC	1.000	PC					
Code	Description	Qty	UOM																						
VI1074A0	4X16 SCREW FOR PLASTIC	2.000	PC																						
VI1220A1	4,2x12 TCB SELF-TAPPIN G SCREW	2.000	PC																						
VM1460A0	XBC/XVC RIGHT DOOR LATCH CAP	1.000	PC																						
VP1531A0	BT CT LEFT HANDLE LATC	1.000	PC																						
<table border="1"> <thead> <tr> <th>Code</th> <th>Description</th> <th>Qty</th> <th>UOM</th> </tr> </thead> <tbody> <tr> <td>VI1074A0</td> <td>4X16 SCREW FOR PLASTIC</td> <td>2.000</td> <td>PC</td> </tr> <tr> <td>VI1220A1</td> <td>4,2x12 TCB SELF-TAPPIN G SCREW</td> <td>2.000</td> <td>PC</td> </tr> <tr> <td>VM1460A0</td> <td>XBC/XVC RIGHT DOOR LATCH CAP</td> <td>1.000</td> <td>PC</td> </tr> <tr> <td>VP1531A0</td> <td>BT CT LEFT HANDLE LATC</td> <td>1.000</td> <td>PC</td> </tr> </tbody> </table>	Code	Description	Qty	UOM	VI1074A0	4X16 SCREW FOR PLASTIC	2.000	PC	VI1220A1	4,2x12 TCB SELF-TAPPIN G SCREW	2.000	PC	VM1460A0	XBC/XVC RIGHT DOOR LATCH CAP	1.000	PC	VP1531A0	BT CT LEFT HANDLE LATC	1.000	PC					
Code	Description	Qty	UOM																						
VI1074A0	4X16 SCREW FOR PLASTIC	2.000	PC																						
VI1220A1	4,2x12 TCB SELF-TAPPIN G SCREW	2.000	PC																						
VM1460A0	XBC/XVC RIGHT DOOR LATCH CAP	1.000	PC																						
VP1531A0	BT CT LEFT HANDLE LATC	1.000	PC																						
<table border="1"> <thead> <tr> <th>Code</th> <th>Description</th> <th>Qty</th> <th>UOM</th> </tr> </thead> <tbody> <tr> <td>VI1074A0</td> <td>4X16 SCREW FOR PLASTIC</td> <td>2.000</td> <td>PC</td> </tr> <tr> <td>VI1220A1</td> <td>4,2x12 TCB SELF-TAPPIN G SCREW</td> <td>2.000</td> <td>PC</td> </tr> <tr> <td>VM1460A0</td> <td>XBC/XVC RIGHT DOOR LATCH CAP</td> <td>1.000</td> <td>PC</td> </tr> <tr> <td>VP1531A0</td> <td>BT CT LEFT HANDLE LATC</td> <td>1.000</td> <td>PC</td> </tr> </tbody> </table>	Code	Description	Qty	UOM	VI1074A0	4X16 SCREW FOR PLASTIC	2.000	PC	VI1220A1	4,2x12 TCB SELF-TAPPIN G SCREW	2.000	PC	VM1460A0	XBC/XVC RIGHT DOOR LATCH CAP	1.000	PC	VP1531A0	BT CT LEFT HANDLE LATC	1.000	PC					
Code	Description	Qty	UOM																						
VI1074A0	4X16 SCREW FOR PLASTIC	2.000	PC																						
VI1220A1	4,2x12 TCB SELF-TAPPIN G SCREW	2.000	PC																						
VM1460A0	XBC/XVC RIGHT DOOR LATCH CAP	1.000	PC																						
VP1531A0	BT CT LEFT HANDLE LATC	1.000	PC																						
VM1195A	HOLES BLANKING PLATE XVC204/304/504/704		VM1195A0	HOLES BLANKING PLATE XVC204/304/504/704																					



COMPONENT			SPARE PART														
Code	Description	Image	Code	Description	Kit components												
VM1240A	NYLON SUPPORT CAP		KVM1240A	4 PCS COUNTER BRACKET SUPPORT CAP KIT	<table border="1"> <thead> <tr> <th>Code</th> <th>Description</th> <th>Qty</th> <th>UOM</th> </tr> </thead> <tbody> <tr> <td>VM1240A0</td> <td>NYLON SUPPORT CAP</td> <td>4.000</td> <td>PC</td> </tr> </tbody> </table>	Code	Description	Qty	UOM	VM1240A0	NYLON SUPPORT CAP	4.000	PC				
Code	Description	Qty	UOM														
VM1240A0	NYLON SUPPORT CAP	4.000	PC														
VM1460A	XBC/XVC RIGHT DOOR LATCH CAP		KVM1460A	XBC/XVC RIGHT DOOR LATCH CAP KIT	<table border="1"> <thead> <tr> <th>Code</th> <th>Description</th> <th>Qty</th> <th>UOM</th> </tr> </thead> <tbody> <tr> <td>V11074A0</td> <td>4X16 SCREW FOR PLASTIC</td> <td>2.000</td> <td>PC</td> </tr> <tr> <td>VM1460A0</td> <td>XBC/XVC RIGHT DOOR LATCH CAP</td> <td>1.000</td> <td>PC</td> </tr> </tbody> </table>	Code	Description	Qty	UOM	V11074A0	4X16 SCREW FOR PLASTIC	2.000	PC	VM1460A0	XBC/XVC RIGHT DOOR LATCH CAP	1.000	PC
Code	Description	Qty	UOM														
V11074A0	4X16 SCREW FOR PLASTIC	2.000	PC														
VM1460A0	XBC/XVC RIGHT DOOR LATCH CAP	1.000	PC														
VM1461A	XBC/XVC LEFT DOOR LATCH COVE		KVM1461A	XBC/XVC LEFT DOOR LATCH COVER KIT	<table border="1"> <thead> <tr> <th>Code</th> <th>Description</th> <th>Qty</th> <th>UOM</th> </tr> </thead> <tbody> <tr> <td>V11074A0</td> <td>4X16 SCREW FOR PLASTIC</td> <td>2.000</td> <td>PC</td> </tr> <tr> <td>VM1461A0</td> <td>XBC/XVC LEFT DOOR LATCH COVER</td> <td>1.000</td> <td>PC</td> </tr> </tbody> </table>	Code	Description	Qty	UOM	V11074A0	4X16 SCREW FOR PLASTIC	2.000	PC	VM1461A0	XBC/XVC LEFT DOOR LATCH COVER	1.000	PC
Code	Description	Qty	UOM														
V11074A0	4X16 SCREW FOR PLASTIC	2.000	PC														
VM1461A0	XBC/XVC LEFT DOOR LATCH COVER	1.000	PC														
VM1974A	CONTROL PANEL CLOSING PLATE		VM1974A0	CONTROL PANEL CLOSING PLATE													
VM1975A	DOOR SUPPORT LOWER BRACKET		VM1975A0	DOOR SUPPORT LOWER BRACKET													



COMPONENT			SPARE PART										
Code	Description	Image	Code	Description	Kit components								
VM2028A	20x10x4 RUBBER WASHER		KVM2028A	20x10x4 RUBBER WASHER 5 PCS. KIT	<table border="1"> <thead> <tr> <th>Code</th> <th>Description</th> <th>Qty</th> <th>UOM</th> </tr> </thead> <tbody> <tr> <td>VM2028A0</td> <td>20x10x4 RUBBER WASHER</td> <td>5.000</td> <td>PC</td> </tr> </tbody> </table>	Code	Description	Qty	UOM	VM2028A0	20x10x4 RUBBER WASHER	5.000	PC
Code	Description	Qty	UOM										
VM2028A0	20x10x4 RUBBER WASHER	5.000	PC										
VM2035A	DRAIN PIPE SUPPORT		KVM2035A	DRAIN PIPE SUPPORT 2 PCS. KI	<table border="1"> <thead> <tr> <th>Code</th> <th>Description</th> <th>Qty</th> <th>UOM</th> </tr> </thead> <tbody> <tr> <td>VM2035A0</td> <td>DRAIN PIPE SUPPORT</td> <td>2.000</td> <td>PC</td> </tr> </tbody> </table>	Code	Description	Qty	UOM	VM2035A0	DRAIN PIPE SUPPORT	2.000	PC
Code	Description	Qty	UOM										
VM2035A0	DRAIN PIPE SUPPORT	2.000	PC										

ASM4081A/0.D00 - Door - FRONT

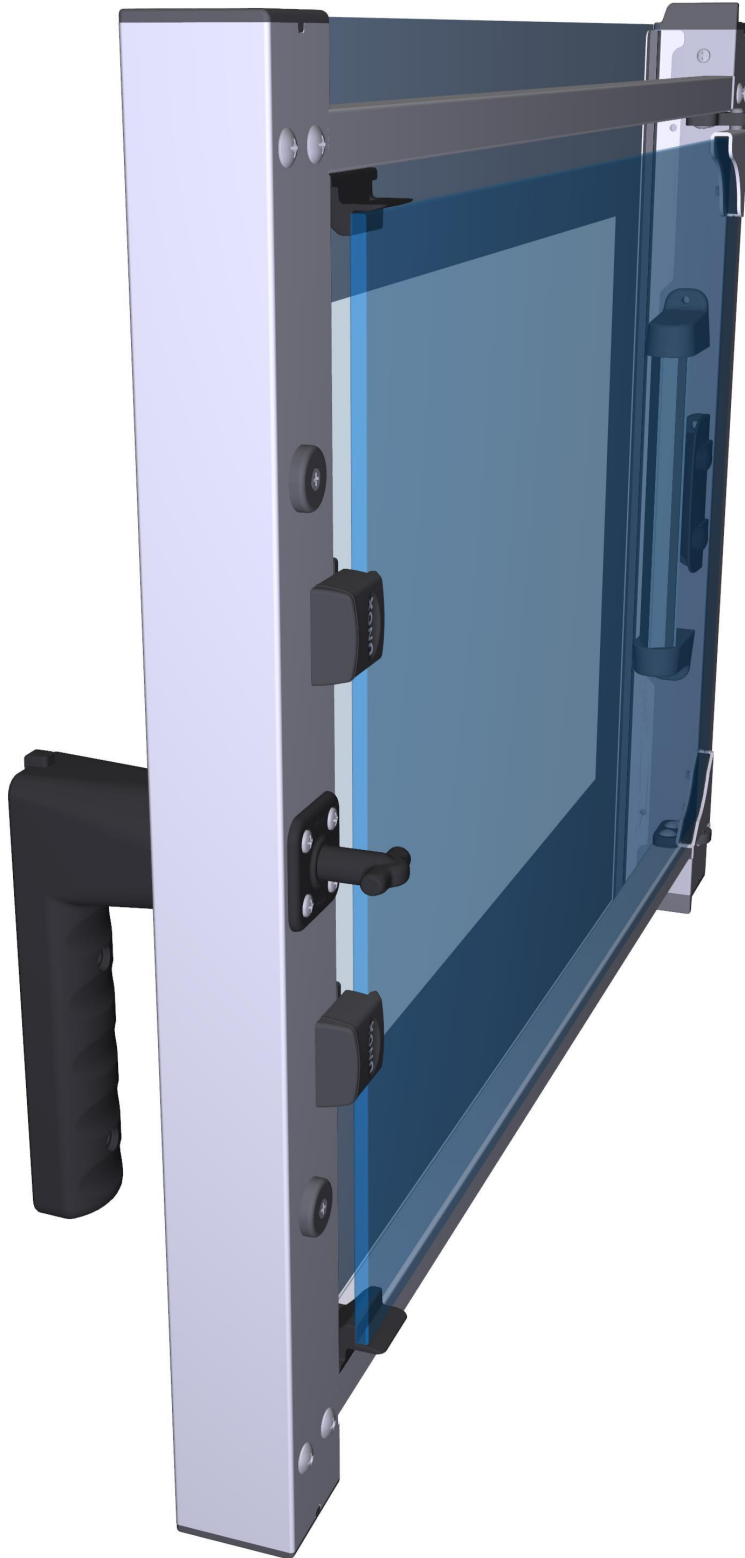

ASM4081A/0.D00 - Door - REAR

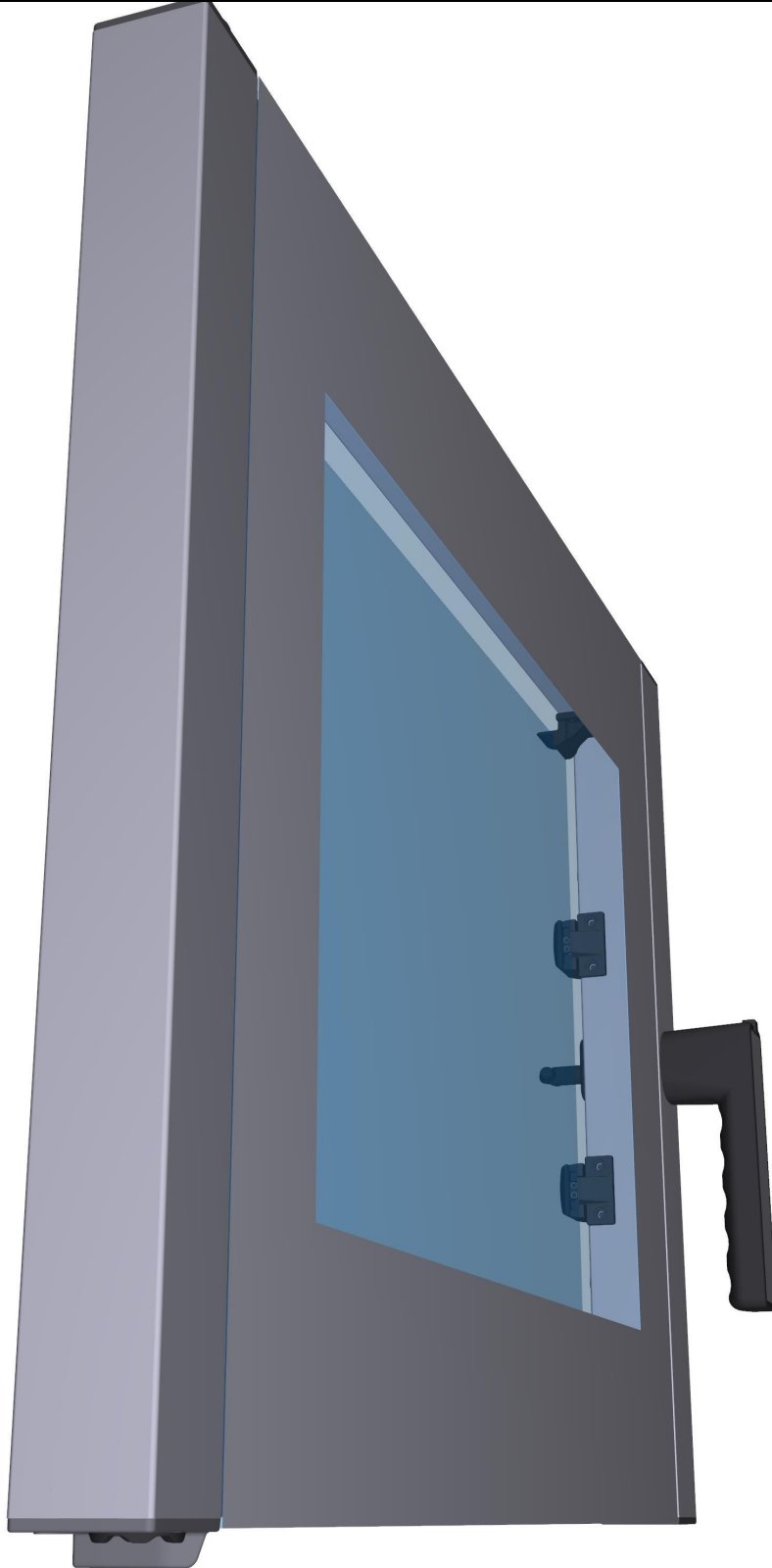







COMPONENT			SPARE PART																																		
Code	Description	Image	Code	Description	Kit components																																
VM1591A	GLASS BRACKET INT. XVC1004		KVM1591A	S.5E INT. GLASS H35 PUSHING BRACKET KIT	<table border="1"> <thead> <tr> <th>Code</th> <th>Description</th> <th>Qty</th> <th>UOM</th> </tr> </thead> <tbody> <tr> <td>V11220A1</td> <td>4,2x12 TCB SELF-TAPPIN G SCREW</td> <td>2.000</td> <td>PC</td> </tr> <tr> <td>VM1591A0</td> <td>GLASS BRACKET INT. XVC1004</td> <td>1.000</td> <td>PC</td> </tr> <tr> <td>VM1630A1</td> <td>INTERNAL GLASS PUSHING CAP</td> <td>2.000</td> <td>PC</td> </tr> </tbody> </table>	Code	Description	Qty	UOM	V11220A1	4,2x12 TCB SELF-TAPPIN G SCREW	2.000	PC	VM1591A0	GLASS BRACKET INT. XVC1004	1.000	PC	VM1630A1	INTERNAL GLASS PUSHING CAP	2.000	PC																
Code	Description	Qty	UOM																																		
V11220A1	4,2x12 TCB SELF-TAPPIN G SCREW	2.000	PC																																		
VM1591A0	GLASS BRACKET INT. XVC1004	1.000	PC																																		
VM1630A1	INTERNAL GLASS PUSHING CAP	2.000	PC																																		
VM1630A	INTERNAL GLASS PUSHING CAP		KVM1630A	CAP FOR INTERNAL GLASS 10 PCS KIT	<table border="1"> <thead> <tr> <th>Code</th> <th>Description</th> <th>Qty</th> <th>UOM</th> </tr> </thead> <tbody> <tr> <td>VM1630A1</td> <td>INTERNAL GLASS PUSHING CAP</td> <td>10.000</td> <td>PC</td> </tr> </tbody> </table>	Code	Description	Qty	UOM	VM1630A1	INTERNAL GLASS PUSHING CAP	10.000	PC																								
Code	Description	Qty	UOM																																		
VM1630A1	INTERNAL GLASS PUSHING CAP	10.000	PC																																		
VM2008A	SPACER FOR MICROSWITCH		KVM2008A	MICROSWITCH SPACER KIT	<table border="1"> <thead> <tr> <th>Code</th> <th>Description</th> <th>Qty</th> <th>UOM</th> </tr> </thead> <tbody> <tr> <td>VM2008A0</td> <td>SPACER FOR MICROSWITC</td> <td>2.000</td> <td>PC</td> </tr> </tbody> </table>	Code	Description	Qty	UOM	VM2008A0	SPACER FOR MICROSWITC	2.000	PC																								
Code	Description	Qty	UOM																																		
VM2008A0	SPACER FOR MICROSWITC	2.000	PC																																		
CR1085A	INTERNAL GLASS UPPER HINGE		KVM0012A	4-5-5E S. INT. GLASS OPENING SYSTEM KIT	<table border="1"> <thead> <tr> <th>Code</th> <th>Description</th> <th>Qty</th> <th>UOM</th> </tr> </thead> <tbody> <tr> <td>CR1085A0</td> <td>INTERNAL GLASS UPPER HINGE</td> <td>1.000</td> <td>PC</td> </tr> <tr> <td>CR1086A0</td> <td>INTERNAL GLASS LOWER HINGE</td> <td>1.000</td> <td>PC</td> </tr> <tr> <td>GN1181A0</td> <td>INTERNAL GLASS HINGE SEAL</td> <td>2.000</td> <td>PC</td> </tr> <tr> <td>V11220A1</td> <td>4,2x12 TCB SELF-TAPPIN G SCREW</td> <td>5.000</td> <td>PC</td> </tr> <tr> <td>V11300A0</td> <td>SCREW M6X12 T1/2T+INOX</td> <td>4.000</td> <td>PC</td> </tr> <tr> <td>V11810A0</td> <td>M6X6 STAINLESS STEEL FLATHEAD SCREW</td> <td>6.000</td> <td>PC</td> </tr> <tr> <td>V11950A0</td> <td>ST. STEEL 4,2X13 TCB SELF-DRILLIN G SCREW</td> <td>6.000</td> <td>PC</td> </tr> </tbody> </table>	Code	Description	Qty	UOM	CR1085A0	INTERNAL GLASS UPPER HINGE	1.000	PC	CR1086A0	INTERNAL GLASS LOWER HINGE	1.000	PC	GN1181A0	INTERNAL GLASS HINGE SEAL	2.000	PC	V11220A1	4,2x12 TCB SELF-TAPPIN G SCREW	5.000	PC	V11300A0	SCREW M6X12 T1/2T+INOX	4.000	PC	V11810A0	M6X6 STAINLESS STEEL FLATHEAD SCREW	6.000	PC	V11950A0	ST. STEEL 4,2X13 TCB SELF-DRILLIN G SCREW	6.000	PC
Code	Description	Qty	UOM																																		
CR1085A0	INTERNAL GLASS UPPER HINGE	1.000	PC																																		
CR1086A0	INTERNAL GLASS LOWER HINGE	1.000	PC																																		
GN1181A0	INTERNAL GLASS HINGE SEAL	2.000	PC																																		
V11220A1	4,2x12 TCB SELF-TAPPIN G SCREW	5.000	PC																																		
V11300A0	SCREW M6X12 T1/2T+INOX	4.000	PC																																		
V11810A0	M6X6 STAINLESS STEEL FLATHEAD SCREW	6.000	PC																																		
V11950A0	ST. STEEL 4,2X13 TCB SELF-DRILLIN G SCREW	6.000	PC																																		

COMPONENT			SPARE PART																														
Code	Description	Image	Code	Description	Kit components																												
CR1085A	INTERNAL GLASS UPPER HINGE		KVM0012A	4-5-5E S. INT. GLASS OPENING SYSTEM KIT	<table border="1"> <thead> <tr> <th>Code</th> <th>Description</th> <th>Qty</th> <th>UOM</th> </tr> </thead> <tbody> <tr> <td>VM1680A0</td> <td>INTERNAL GLASS HINGE</td> <td>2.000</td> <td>PC</td> </tr> <tr> <td>VM2043A0</td> <td>UPPER - LOWER GLASS SUPPORT</td> <td>2.000</td> <td>PC</td> </tr> <tr> <td>VM2237A1</td> <td>HANDLE SHAFT WITH LATCH</td> <td>2.000</td> <td>PC</td> </tr> </tbody> </table>	Code	Description	Qty	UOM	VM1680A0	INTERNAL GLASS HINGE	2.000	PC	VM2043A0	UPPER - LOWER GLASS SUPPORT	2.000	PC	VM2237A1	HANDLE SHAFT WITH LATCH	2.000	PC												
			Code	Description	Qty	UOM																											
VM1680A0	INTERNAL GLASS HINGE	2.000	PC																														
VM2043A0	UPPER - LOWER GLASS SUPPORT	2.000	PC																														
VM2237A1	HANDLE SHAFT WITH LATCH	2.000	PC																														
KCR1085A	INTERNAL GLASS UPPER HINGE KIT	<table border="1"> <thead> <tr> <th>Code</th> <th>Description</th> <th>Qty</th> <th>UOM</th> </tr> </thead> <tbody> <tr> <td>CR1085A0</td> <td>INTERNAL GLASS UPPER HINGE</td> <td>1.000</td> <td>PC</td> </tr> <tr> <td>GN1181A0</td> <td>INTERNAL GLASS HINGE SEAL</td> <td>1.000</td> <td>PC</td> </tr> <tr> <td>VI1810A0</td> <td>M6X6 STAINLESS STEEL FLATHEAD SCREW</td> <td>3.000</td> <td>PC</td> </tr> </tbody> </table>	Code	Description	Qty	UOM	CR1085A0	INTERNAL GLASS UPPER HINGE	1.000	PC	GN1181A0	INTERNAL GLASS HINGE SEAL	1.000	PC	VI1810A0	M6X6 STAINLESS STEEL FLATHEAD SCREW	3.000	PC															
Code	Description	Qty	UOM																														
CR1085A0	INTERNAL GLASS UPPER HINGE	1.000	PC																														
GN1181A0	INTERNAL GLASS HINGE SEAL	1.000	PC																														
VI1810A0	M6X6 STAINLESS STEEL FLATHEAD SCREW	3.000	PC																														
GN1181A	INTERNAL GLASS HINGE SEAL		KGN1181A	INT. GLASS HINGE GASKET 2 PCS KIT	<table border="1"> <thead> <tr> <th>Code</th> <th>Description</th> <th>Qty</th> <th>UOM</th> </tr> </thead> <tbody> <tr> <td>GN1181A0</td> <td>INTERNAL GLASS HINGE SEAL</td> <td>2.000</td> <td>PC</td> </tr> </tbody> </table>	Code	Description	Qty	UOM	GN1181A0	INTERNAL GLASS HINGE SEAL	2.000	PC																				
Code	Description	Qty	UOM																														
GN1181A0	INTERNAL GLASS HINGE SEAL	2.000	PC																														
CR1086A	INTERNAL GLASS LOWER HINGE		KVM0012A	4-5-5E S. INT. GLASS OPENING SYSTEM KIT	<table border="1"> <thead> <tr> <th>Code</th> <th>Description</th> <th>Qty</th> <th>UOM</th> </tr> </thead> <tbody> <tr> <td>CR1085A0</td> <td>INTERNAL GLASS UPPER HINGE</td> <td>1.000</td> <td>PC</td> </tr> <tr> <td>CR1086A0</td> <td>INTERNAL GLASS LOWER HINGE</td> <td>1.000</td> <td>PC</td> </tr> <tr> <td>GN1181A0</td> <td>INTERNAL GLASS HINGE SEAL</td> <td>2.000</td> <td>PC</td> </tr> <tr> <td>VI1220A1</td> <td>4,2x12 TCB SELF-TAPPIN G SCREW</td> <td>5.000</td> <td>PC</td> </tr> <tr> <td>VI1300A0</td> <td>SCREW M6X12 T1/2T+INOX</td> <td>4.000</td> <td>PC</td> </tr> <tr> <td>VI1810A0</td> <td>M6X6 STAINLESS STEEL FLATHEAD SCREW</td> <td>6.000</td> <td>PC</td> </tr> </tbody> </table>	Code	Description	Qty	UOM	CR1085A0	INTERNAL GLASS UPPER HINGE	1.000	PC	CR1086A0	INTERNAL GLASS LOWER HINGE	1.000	PC	GN1181A0	INTERNAL GLASS HINGE SEAL	2.000	PC	VI1220A1	4,2x12 TCB SELF-TAPPIN G SCREW	5.000	PC	VI1300A0	SCREW M6X12 T1/2T+INOX	4.000	PC	VI1810A0	M6X6 STAINLESS STEEL FLATHEAD SCREW	6.000	PC
					Code	Description	Qty	UOM																									
					CR1085A0	INTERNAL GLASS UPPER HINGE	1.000	PC																									
					CR1086A0	INTERNAL GLASS LOWER HINGE	1.000	PC																									
					GN1181A0	INTERNAL GLASS HINGE SEAL	2.000	PC																									
					VI1220A1	4,2x12 TCB SELF-TAPPIN G SCREW	5.000	PC																									
VI1300A0	SCREW M6X12 T1/2T+INOX	4.000	PC																														
VI1810A0	M6X6 STAINLESS STEEL FLATHEAD SCREW	6.000	PC																														

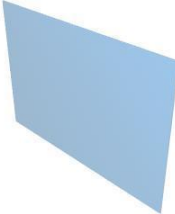

COMPONENT			SPARE PART																						
Code	Description	Image	Code	Description	Kit components																				
CR1086A	INTERNAL GLASS LOWER HINGE		KVM0012A	4-5-5E S. INT. GLASS OPENING SYSTEM KIT	<table border="1"> <thead> <tr> <th>Code</th> <th>Description</th> <th>Qty</th> <th>UOM</th> </tr> </thead> <tbody> <tr> <td>VI1950A0</td> <td>ST. STEEL 4.2X13 TCB SELF-DRILLIN G SCREW</td> <td>6.000</td> <td>PC</td> </tr> <tr> <td>VM1680A0</td> <td>INTERNAL GLASS HINGE</td> <td>2.000</td> <td>PC</td> </tr> <tr> <td>VM2043A0</td> <td>UPPER - LOWER GLASS SUPPORT</td> <td>2.000</td> <td>PC</td> </tr> <tr> <td>VM2237A1</td> <td>HANDLE SHAFT WITH LATCH</td> <td>2.000</td> <td>PC</td> </tr> </tbody> </table>	Code	Description	Qty	UOM	VI1950A0	ST. STEEL 4.2X13 TCB SELF-DRILLIN G SCREW	6.000	PC	VM1680A0	INTERNAL GLASS HINGE	2.000	PC	VM2043A0	UPPER - LOWER GLASS SUPPORT	2.000	PC	VM2237A1	HANDLE SHAFT WITH LATCH	2.000	PC
			Code	Description	Qty	UOM																			
VI1950A0	ST. STEEL 4.2X13 TCB SELF-DRILLIN G SCREW	6.000	PC																						
VM1680A0	INTERNAL GLASS HINGE	2.000	PC																						
VM2043A0	UPPER - LOWER GLASS SUPPORT	2.000	PC																						
VM2237A1	HANDLE SHAFT WITH LATCH	2.000	PC																						
KCR1086A	INTERNAL GLASS LOWER HINGE KIT	<table border="1"> <thead> <tr> <th>Code</th> <th>Description</th> <th>Qty</th> <th>UOM</th> </tr> </thead> <tbody> <tr> <td>CR1086A0</td> <td>INTERNAL GLASS LOWER HINGE</td> <td>1.000</td> <td>PC</td> </tr> <tr> <td>GN1181A0</td> <td>INTERNAL GLASS HINGE SEAL</td> <td>1.000</td> <td>PC</td> </tr> <tr> <td>VI1810A0</td> <td>M6X6 STAINLESS STEEL FLATHEAD SCREW</td> <td>3.000</td> <td>PC</td> </tr> </tbody> </table>	Code	Description	Qty	UOM	CR1086A0	INTERNAL GLASS LOWER HINGE	1.000	PC	GN1181A0	INTERNAL GLASS HINGE SEAL	1.000	PC	VI1810A0	M6X6 STAINLESS STEEL FLATHEAD SCREW	3.000	PC							
Code	Description	Qty	UOM																						
CR1086A0	INTERNAL GLASS LOWER HINGE	1.000	PC																						
GN1181A0	INTERNAL GLASS HINGE SEAL	1.000	PC																						
VI1810A0	M6X6 STAINLESS STEEL FLATHEAD SCREW	3.000	PC																						
GN1181A	INTERNAL GLASS HINGE SEAL		KG1181A	INT. GLASS HINGE GASKET 2 PCS KIT	<table border="1"> <thead> <tr> <th>Code</th> <th>Description</th> <th>Qty</th> <th>UOM</th> </tr> </thead> <tbody> <tr> <td>GN1181A0</td> <td>INTERNAL GLASS HINGE SEAL</td> <td>2.000</td> <td>PC</td> </tr> </tbody> </table>	Code	Description	Qty	UOM	GN1181A0	INTERNAL GLASS HINGE SEAL	2.000	PC												
Code	Description	Qty	UOM																						
GN1181A0	INTERNAL GLASS HINGE SEAL	2.000	PC																						
VT1095A	XL375/XV393/XVC30 4-305 INNER GLASS		KVT1095A	XL375/XV393/XVC30 4-305 INNER GLASS KIT	<table border="1"> <thead> <tr> <th>Code</th> <th>Description</th> <th>Qty</th> <th>UOM</th> </tr> </thead> <tbody> <tr> <td>VT1095A0</td> <td>XL375/XV393/X VC304-305 INNER GLASS</td> <td>1.000</td> <td>PC</td> </tr> </tbody> </table>	Code	Description	Qty	UOM	VT1095A0	XL375/XV393/X VC304-305 INNER GLASS	1.000	PC												
Code	Description	Qty	UOM																						
VT1095A0	XL375/XV393/X VC304-305 INNER GLASS	1.000	PC																						





COMPONENT			SPARE PART																																										
Code	Description	Image	Code	Description	Kit components																																								
LP1044A	LUX LED BAR		KLP1044A	LUX LED BAR KIT	<table border="1"> <thead> <tr> <th>Code</th> <th>Description</th> <th>Qty</th> <th>UOM</th> </tr> </thead> <tbody> <tr> <td>CE1455A0</td> <td>TIP END FITTING</td> <td>2.000</td> <td>PC</td> </tr> <tr> <td>CE1730A0</td> <td>PVC CABLE NP 2 X AWG22 STYLE 2095</td> <td>1.000</td> <td>M</td> </tr> <tr> <td>CE1735A0</td> <td>MINIFIT FEMALE END FITTING</td> <td>2.000</td> <td>PC</td> </tr> <tr> <td>CE1740A0</td> <td>MINIFIT MALE END FITTING</td> <td>2.000</td> <td>PC</td> </tr> <tr> <td>CE1745A0</td> <td>2 WAYS FEMALE MINIFIT CONNECTOR</td> <td>1.000</td> <td>PC</td> </tr> <tr> <td>CE1750A0</td> <td>3 WAYS MALE MINIFIT CONNECTOR</td> <td>1.000</td> <td>PC</td> </tr> <tr> <td>LP1044A0</td> <td>LUX LED BAR</td> <td>1.000</td> <td>PC</td> </tr> <tr> <td>VM1620A0</td> <td>LED BAR LOWER SUPPORT</td> <td>1.000</td> <td>PC</td> </tr> <tr> <td>VM1621A0</td> <td>LED BAR UPPER SUPPORT</td> <td>1.000</td> <td>PC</td> </tr> </tbody> </table>	Code	Description	Qty	UOM	CE1455A0	TIP END FITTING	2.000	PC	CE1730A0	PVC CABLE NP 2 X AWG22 STYLE 2095	1.000	M	CE1735A0	MINIFIT FEMALE END FITTING	2.000	PC	CE1740A0	MINIFIT MALE END FITTING	2.000	PC	CE1745A0	2 WAYS FEMALE MINIFIT CONNECTOR	1.000	PC	CE1750A0	3 WAYS MALE MINIFIT CONNECTOR	1.000	PC	LP1044A0	LUX LED BAR	1.000	PC	VM1620A0	LED BAR LOWER SUPPORT	1.000	PC	VM1621A0	LED BAR UPPER SUPPORT	1.000	PC
					Code	Description	Qty	UOM																																					
					CE1455A0	TIP END FITTING	2.000	PC																																					
					CE1730A0	PVC CABLE NP 2 X AWG22 STYLE 2095	1.000	M																																					
					CE1735A0	MINIFIT FEMALE END FITTING	2.000	PC																																					
					CE1740A0	MINIFIT MALE END FITTING	2.000	PC																																					
					CE1745A0	2 WAYS FEMALE MINIFIT CONNECTOR	1.000	PC																																					
					CE1750A0	3 WAYS MALE MINIFIT CONNECTOR	1.000	PC																																					
					LP1044A0	LUX LED BAR	1.000	PC																																					
					VM1620A0	LED BAR LOWER SUPPORT	1.000	PC																																					
VM1621A0	LED BAR UPPER SUPPORT	1.000	PC																																										
VM1620A	LED BAR LOWER SUPPORT		KLP1044A	LUX LED BAR KIT	<table border="1"> <thead> <tr> <th>Code</th> <th>Description</th> <th>Qty</th> <th>UOM</th> </tr> </thead> <tbody> <tr> <td>CE1455A0</td> <td>TIP END FITTING</td> <td>2.000</td> <td>PC</td> </tr> <tr> <td>CE1730A0</td> <td>PVC CABLE NP 2 X AWG22 STYLE 2095</td> <td>1.000</td> <td>M</td> </tr> <tr> <td>CE1735A0</td> <td>MINIFIT FEMALE END FITTING</td> <td>2.000</td> <td>PC</td> </tr> <tr> <td>CE1740A0</td> <td>MINIFIT MALE END FITTING</td> <td>2.000</td> <td>PC</td> </tr> <tr> <td>CE1745A0</td> <td>2 WAYS FEMALE MINIFIT CONNECTOR</td> <td>1.000</td> <td>PC</td> </tr> <tr> <td>CE1750A0</td> <td>3 WAYS MALE MINIFIT CONNECTOR</td> <td>1.000</td> <td>PC</td> </tr> <tr> <td>LP1044A0</td> <td>LUX LED BAR</td> <td>1.000</td> <td>PC</td> </tr> <tr> <td>VM1620A0</td> <td>LED BAR LOWER SUPPORT</td> <td>1.000</td> <td>PC</td> </tr> <tr> <td>VM1621A0</td> <td>LED BAR UPPER SUPPORT</td> <td>1.000</td> <td>PC</td> </tr> </tbody> </table>	Code	Description	Qty	UOM	CE1455A0	TIP END FITTING	2.000	PC	CE1730A0	PVC CABLE NP 2 X AWG22 STYLE 2095	1.000	M	CE1735A0	MINIFIT FEMALE END FITTING	2.000	PC	CE1740A0	MINIFIT MALE END FITTING	2.000	PC	CE1745A0	2 WAYS FEMALE MINIFIT CONNECTOR	1.000	PC	CE1750A0	3 WAYS MALE MINIFIT CONNECTOR	1.000	PC	LP1044A0	LUX LED BAR	1.000	PC	VM1620A0	LED BAR LOWER SUPPORT	1.000	PC	VM1621A0	LED BAR UPPER SUPPORT	1.000	PC
					Code	Description	Qty	UOM																																					
					CE1455A0	TIP END FITTING	2.000	PC																																					
					CE1730A0	PVC CABLE NP 2 X AWG22 STYLE 2095	1.000	M																																					
					CE1735A0	MINIFIT FEMALE END FITTING	2.000	PC																																					
					CE1740A0	MINIFIT MALE END FITTING	2.000	PC																																					
					CE1745A0	2 WAYS FEMALE MINIFIT CONNECTOR	1.000	PC																																					
					CE1750A0	3 WAYS MALE MINIFIT CONNECTOR	1.000	PC																																					
					LP1044A0	LUX LED BAR	1.000	PC																																					
					VM1620A0	LED BAR LOWER SUPPORT	1.000	PC																																					
VM1621A0	LED BAR UPPER SUPPORT	1.000	PC																																										
			KLP1007A	L200 LED BAR KIT	<table border="1"> <thead> <tr> <th>Code</th> <th>Description</th> <th>Qty</th> <th>UOM</th> </tr> </thead> <tbody> <tr> <td>CE1455A0</td> <td>TIP END FITTING</td> <td>2.000</td> <td>PC</td> </tr> </tbody> </table>	Code	Description	Qty	UOM	CE1455A0	TIP END FITTING	2.000	PC																																
Code	Description	Qty	UOM																																										
CE1455A0	TIP END FITTING	2.000	PC																																										



COMPONENT			SPARE PART																																						
Code	Description	Image	Code	Description	Kit components																																				
VM1620A	LED BAR LOWER SUPPORT		KLP1007A	L200 LED BAR KIT	<table border="1"> <thead> <tr> <th>Code</th> <th>Description</th> <th>Qty</th> <th>UOM</th> </tr> </thead> <tbody> <tr> <td>CE1730A0</td> <td>PVC CABLE NP 2 X AWG22 STYLE 2095</td> <td>1.000</td> <td>M</td> </tr> <tr> <td>CE1735A0</td> <td>MINIFIT FEMALE END FITTING</td> <td>2.000</td> <td>PC</td> </tr> <tr> <td>CE1740A0</td> <td>MINIFIT MALE END FITTING</td> <td>2.000</td> <td>PC</td> </tr> <tr> <td>CE1745A0</td> <td>2 WAYS FEMALE MINIFIT CONNECTOR</td> <td>1.000</td> <td>PC</td> </tr> <tr> <td>CE1750A0</td> <td>3 WAYS MALE MINIFIT CONNECTOR</td> <td>1.000</td> <td>PC</td> </tr> <tr> <td>LP1007A0</td> <td>LED LIGHT BAR L200</td> <td>1.000</td> <td>PC</td> </tr> <tr> <td>VM1620A0</td> <td>LED BAR LOWER SUPPORT</td> <td>1.000</td> <td>PC</td> </tr> <tr> <td>VM1621A0</td> <td>LED BAR UPPER SUPPORT</td> <td>1.000</td> <td>PC</td> </tr> </tbody> </table>	Code	Description	Qty	UOM	CE1730A0	PVC CABLE NP 2 X AWG22 STYLE 2095	1.000	M	CE1735A0	MINIFIT FEMALE END FITTING	2.000	PC	CE1740A0	MINIFIT MALE END FITTING	2.000	PC	CE1745A0	2 WAYS FEMALE MINIFIT CONNECTOR	1.000	PC	CE1750A0	3 WAYS MALE MINIFIT CONNECTOR	1.000	PC	LP1007A0	LED LIGHT BAR L200	1.000	PC	VM1620A0	LED BAR LOWER SUPPORT	1.000	PC	VM1621A0	LED BAR UPPER SUPPORT	1.000	PC
					Code	Description	Qty	UOM																																	
					CE1730A0	PVC CABLE NP 2 X AWG22 STYLE 2095	1.000	M																																	
					CE1735A0	MINIFIT FEMALE END FITTING	2.000	PC																																	
					CE1740A0	MINIFIT MALE END FITTING	2.000	PC																																	
					CE1745A0	2 WAYS FEMALE MINIFIT CONNECTOR	1.000	PC																																	
					CE1750A0	3 WAYS MALE MINIFIT CONNECTOR	1.000	PC																																	
					LP1007A0	LED LIGHT BAR L200	1.000	PC																																	
					VM1620A0	LED BAR LOWER SUPPORT	1.000	PC																																	
					VM1621A0	LED BAR UPPER SUPPORT	1.000	PC																																	
KLP1004B	L1000 LED BAR KIT	<table border="1"> <thead> <tr> <th>Code</th> <th>Description</th> <th>Qty</th> <th>UOM</th> </tr> </thead> <tbody> <tr> <td>CE1730A0</td> <td>PVC CABLE NP 2 X AWG22 STYLE 2095</td> <td>1.000</td> <td>M</td> </tr> <tr> <td>CE1735A0</td> <td>MINIFIT FEMALE END FITTING</td> <td>2.000</td> <td>PC</td> </tr> <tr> <td>CE1740A0</td> <td>MINIFIT MALE END FITTING</td> <td>2.000</td> <td>PC</td> </tr> <tr> <td>CE1745A0</td> <td>2 WAYS FEMALE MINIFIT CONNECTOR</td> <td>1.000</td> <td>PC</td> </tr> <tr> <td>CE1750A0</td> <td>3 WAYS MALE MINIFIT CONNECTOR</td> <td>1.000</td> <td>PC</td> </tr> <tr> <td>LP1004B0</td> <td>LEB LIGHTING BAR L1000</td> <td>1.000</td> <td>PC</td> </tr> <tr> <td>VM1620A0</td> <td>LED BAR LOWER SUPPORT</td> <td>1.000</td> <td>PC</td> </tr> <tr> <td>VM1621A0</td> <td>LED BAR UPPER SUPPORT</td> <td>1.000</td> <td>PC</td> </tr> </tbody> </table>	Code	Description	Qty	UOM	CE1730A0	PVC CABLE NP 2 X AWG22 STYLE 2095	1.000	M	CE1735A0	MINIFIT FEMALE END FITTING	2.000	PC	CE1740A0	MINIFIT MALE END FITTING	2.000	PC	CE1745A0	2 WAYS FEMALE MINIFIT CONNECTOR	1.000	PC	CE1750A0	3 WAYS MALE MINIFIT CONNECTOR	1.000	PC	LP1004B0	LEB LIGHTING BAR L1000	1.000	PC	VM1620A0	LED BAR LOWER SUPPORT	1.000	PC	VM1621A0	LED BAR UPPER SUPPORT	1.000	PC			
		Code	Description	Qty	UOM																																				
		CE1730A0	PVC CABLE NP 2 X AWG22 STYLE 2095	1.000	M																																				
		CE1735A0	MINIFIT FEMALE END FITTING	2.000	PC																																				
		CE1740A0	MINIFIT MALE END FITTING	2.000	PC																																				
		CE1745A0	2 WAYS FEMALE MINIFIT CONNECTOR	1.000	PC																																				
		CE1750A0	3 WAYS MALE MINIFIT CONNECTOR	1.000	PC																																				
		LP1004B0	LEB LIGHTING BAR L1000	1.000	PC																																				
		VM1620A0	LED BAR LOWER SUPPORT	1.000	PC																																				
		VM1621A0	LED BAR UPPER SUPPORT	1.000	PC																																				
KLP1003B	2017 LED BAR KIT	<table border="1"> <thead> <tr> <th>Code</th> <th>Description</th> <th>Qty</th> <th>UOM</th> </tr> </thead> <tbody> <tr> <td>CE1730A0</td> <td>PVC CABLE NP 2 X AWG22 STYLE 2095</td> <td>1.000</td> <td>M</td> </tr> </tbody> </table>	Code	Description	Qty	UOM	CE1730A0	PVC CABLE NP 2 X AWG22 STYLE 2095	1.000	M																															
Code	Description	Qty	UOM																																						
CE1730A0	PVC CABLE NP 2 X AWG22 STYLE 2095	1.000	M																																						



COMPONENT			SPARE PART																																																																																												
Code	Description	Image	Code	Description	Kit components																																																																																										
VM1620A	LED BAR LOWER SUPPORT		KLP1003B	2017 LED BAR KIT	<table border="1"> <thead> <tr> <th>Code</th> <th>Description</th> <th>Qty</th> <th>UOM</th> </tr> </thead> <tbody> <tr> <td>CE1735A0</td> <td>MINIFIT FEMALE END FITTING</td> <td>2.000</td> <td>PC</td> </tr> <tr> <td>CE1740A0</td> <td>MINIFIT MALE END FITTING</td> <td>2.000</td> <td>PC</td> </tr> <tr> <td>CE1745A0</td> <td>2 WAYS FEMALE MINIFIT CONNECTOR</td> <td>1.000</td> <td>PC</td> </tr> <tr> <td>CE1750A0</td> <td>3 WAYS MALE MINIFIT CONNECTOR</td> <td>1.000</td> <td>PC</td> </tr> <tr> <td>LP1003B0</td> <td>LED LIGHT BAR L600</td> <td>1.000</td> <td>PC</td> </tr> <tr> <td>VM1620A0</td> <td>LED BAR LOWER SUPPORT</td> <td>1.000</td> <td>PC</td> </tr> <tr> <td>VM1621A0</td> <td>LED BAR UPPER SUPPORT</td> <td>1.000</td> <td>PC</td> </tr> <tr> <td>VM1794A0</td> <td>250x4.8 PA66 BLACK CLAMP</td> <td>2.000</td> <td>PC</td> </tr> </tbody> </table>	Code	Description	Qty	UOM	CE1735A0	MINIFIT FEMALE END FITTING	2.000	PC	CE1740A0	MINIFIT MALE END FITTING	2.000	PC	CE1745A0	2 WAYS FEMALE MINIFIT CONNECTOR	1.000	PC	CE1750A0	3 WAYS MALE MINIFIT CONNECTOR	1.000	PC	LP1003B0	LED LIGHT BAR L600	1.000	PC	VM1620A0	LED BAR LOWER SUPPORT	1.000	PC	VM1621A0	LED BAR UPPER SUPPORT	1.000	PC	VM1794A0	250x4.8 PA66 BLACK CLAMP	2.000	PC	KLP1002B	L400 LED BAR KIT	<table border="1"> <thead> <tr> <th>Code</th> <th>Description</th> <th>Qty</th> <th>UOM</th> </tr> </thead> <tbody> <tr> <td>CE1455A0</td> <td>TIP END FITTING</td> <td>2.000</td> <td>PC</td> </tr> <tr> <td>CE1730A0</td> <td>PVC CABLE NP 2 X AWG22 STYLE 2095</td> <td>1.000</td> <td>M</td> </tr> <tr> <td>CE1735A0</td> <td>MINIFIT FEMALE END FITTING</td> <td>2.000</td> <td>PC</td> </tr> <tr> <td>CE1740A0</td> <td>MINIFIT MALE END FITTING</td> <td>2.000</td> <td>PC</td> </tr> <tr> <td>CE1745A0</td> <td>2 WAYS FEMALE MINIFIT CONNECTOR</td> <td>1.000</td> <td>PC</td> </tr> <tr> <td>CE1750A0</td> <td>3 WAYS MALE MINIFIT CONNECTOR</td> <td>1.000</td> <td>PC</td> </tr> <tr> <td>LP1002B0</td> <td>LED LIGHTING BAR L400</td> <td>1.000</td> <td>PC</td> </tr> <tr> <td>VM1620A0</td> <td>LED BAR LOWER SUPPORT</td> <td>1.000</td> <td>PC</td> </tr> <tr> <td>VM1621A0</td> <td>LED BAR UPPER SUPPORT</td> <td>1.000</td> <td>PC</td> </tr> </tbody> </table>	Code	Description	Qty	UOM	CE1455A0	TIP END FITTING	2.000	PC	CE1730A0	PVC CABLE NP 2 X AWG22 STYLE 2095	1.000	M	CE1735A0	MINIFIT FEMALE END FITTING	2.000	PC	CE1740A0	MINIFIT MALE END FITTING	2.000	PC	CE1745A0	2 WAYS FEMALE MINIFIT CONNECTOR	1.000	PC	CE1750A0	3 WAYS MALE MINIFIT CONNECTOR	1.000	PC	LP1002B0	LED LIGHTING BAR L400	1.000	PC	VM1620A0	LED BAR LOWER SUPPORT	1.000	PC	VM1621A0	LED BAR UPPER SUPPORT	1.000	PC	KLP1001B	L300 LED BAR KIT	<table border="1"> <thead> <tr> <th>Code</th> <th>Description</th> <th>Qty</th> <th>UOM</th> </tr> </thead> <tbody> <tr> <td>CE1455A0</td> <td>TIP END FITTING</td> <td>2.000</td> <td>PC</td> </tr> </tbody> </table>	Code	Description	Qty	UOM	CE1455A0	TIP END FITTING	2.000	PC
			Code	Description	Qty	UOM																																																																																									
			CE1735A0	MINIFIT FEMALE END FITTING	2.000	PC																																																																																									
CE1740A0	MINIFIT MALE END FITTING	2.000	PC																																																																																												
CE1745A0	2 WAYS FEMALE MINIFIT CONNECTOR	1.000	PC																																																																																												
CE1750A0	3 WAYS MALE MINIFIT CONNECTOR	1.000	PC																																																																																												
LP1003B0	LED LIGHT BAR L600	1.000	PC																																																																																												
VM1620A0	LED BAR LOWER SUPPORT	1.000	PC																																																																																												
VM1621A0	LED BAR UPPER SUPPORT	1.000	PC																																																																																												
VM1794A0	250x4.8 PA66 BLACK CLAMP	2.000	PC																																																																																												
Code	Description	Qty	UOM																																																																																												
CE1455A0	TIP END FITTING	2.000	PC																																																																																												
CE1730A0	PVC CABLE NP 2 X AWG22 STYLE 2095	1.000	M																																																																																												
CE1735A0	MINIFIT FEMALE END FITTING	2.000	PC																																																																																												
CE1740A0	MINIFIT MALE END FITTING	2.000	PC																																																																																												
CE1745A0	2 WAYS FEMALE MINIFIT CONNECTOR	1.000	PC																																																																																												
CE1750A0	3 WAYS MALE MINIFIT CONNECTOR	1.000	PC																																																																																												
LP1002B0	LED LIGHTING BAR L400	1.000	PC																																																																																												
VM1620A0	LED BAR LOWER SUPPORT	1.000	PC																																																																																												
VM1621A0	LED BAR UPPER SUPPORT	1.000	PC																																																																																												
Code	Description	Qty	UOM																																																																																												
CE1455A0	TIP END FITTING	2.000	PC																																																																																												

COMPONENT			SPARE PART																																																									
Code	Description	Image	Code	Description	Kit components																																																							
VM1620A	LED BAR LOWER SUPPORT		KLP1001B	L300 LED BAR KIT	<table border="1"> <thead> <tr> <th>Code</th> <th>Description</th> <th>Qty</th> <th>UOM</th> </tr> </thead> <tbody> <tr> <td>CE1730A0</td> <td>PVC CABLE NP 2 X AWG22 STYLE 2095</td> <td>1.000</td> <td>M</td> </tr> <tr> <td>CE1735A0</td> <td>MINIFIT FEMALE END FITTING</td> <td>2.000</td> <td>PC</td> </tr> <tr> <td>CE1740A0</td> <td>MINIFIT MALE END FITTING</td> <td>2.000</td> <td>PC</td> </tr> <tr> <td>CE1745A0</td> <td>2 WAYS FEMALE MINIFIT CONNECTOR</td> <td>1.000</td> <td>PC</td> </tr> <tr> <td>CE1750A0</td> <td>3 WAYS MALE MINIFIT CONNECTOR</td> <td>1.000</td> <td>PC</td> </tr> <tr> <td>LP1001B0</td> <td>LED LIGHTING BAR L300</td> <td>1.000</td> <td>PC</td> </tr> <tr> <td>VM1620A0</td> <td>LED BAR LOWER SUPPORT</td> <td>1.000</td> <td>PC</td> </tr> <tr> <td>VM1621A0</td> <td>LED BAR UPPER SUPPORT</td> <td>1.000</td> <td>PC</td> </tr> </tbody> </table>	Code	Description	Qty	UOM	CE1730A0	PVC CABLE NP 2 X AWG22 STYLE 2095	1.000	M	CE1735A0	MINIFIT FEMALE END FITTING	2.000	PC	CE1740A0	MINIFIT MALE END FITTING	2.000	PC	CE1745A0	2 WAYS FEMALE MINIFIT CONNECTOR	1.000	PC	CE1750A0	3 WAYS MALE MINIFIT CONNECTOR	1.000	PC	LP1001B0	LED LIGHTING BAR L300	1.000	PC	VM1620A0	LED BAR LOWER SUPPORT	1.000	PC	VM1621A0	LED BAR UPPER SUPPORT	1.000	PC	KLP1000A	L100 LED BAR KIT	<table border="1"> <thead> <tr> <th>Code</th> <th>Description</th> <th>Qty</th> <th>UOM</th> </tr> </thead> <tbody> <tr> <td>LP1000A0</td> <td>LED LIGHTING BAR L100</td> <td>1.000</td> <td>PC</td> </tr> <tr> <td>VM1620A0</td> <td>LED BAR LOWER SUPPORT</td> <td>1.000</td> <td>PC</td> </tr> <tr> <td>VM1621A0</td> <td>LED BAR UPPER SUPPORT</td> <td>1.000</td> <td>PC</td> </tr> </tbody> </table>	Code	Description	Qty	UOM	LP1000A0	LED LIGHTING BAR L100	1.000	PC	VM1620A0	LED BAR LOWER SUPPORT	1.000	PC	VM1621A0	LED BAR UPPER SUPPORT	1.000	PC
					Code	Description	Qty	UOM																																																				
CE1730A0	PVC CABLE NP 2 X AWG22 STYLE 2095	1.000	M																																																									
CE1735A0	MINIFIT FEMALE END FITTING	2.000	PC																																																									
CE1740A0	MINIFIT MALE END FITTING	2.000	PC																																																									
CE1745A0	2 WAYS FEMALE MINIFIT CONNECTOR	1.000	PC																																																									
CE1750A0	3 WAYS MALE MINIFIT CONNECTOR	1.000	PC																																																									
LP1001B0	LED LIGHTING BAR L300	1.000	PC																																																									
VM1620A0	LED BAR LOWER SUPPORT	1.000	PC																																																									
VM1621A0	LED BAR UPPER SUPPORT	1.000	PC																																																									
Code	Description	Qty	UOM																																																									
LP1000A0	LED LIGHTING BAR L100	1.000	PC																																																									
VM1620A0	LED BAR LOWER SUPPORT	1.000	PC																																																									
VM1621A0	LED BAR UPPER SUPPORT	1.000	PC																																																									
VM1621A	LED BAR UPPER SUPPORT		KLP1044A	LUX LED BAR KIT	<table border="1"> <thead> <tr> <th>Code</th> <th>Description</th> <th>Qty</th> <th>UOM</th> </tr> </thead> <tbody> <tr> <td>CE1455A0</td> <td>TIP END FITTING</td> <td>2.000</td> <td>PC</td> </tr> <tr> <td>CE1730A0</td> <td>PVC CABLE NP 2 X AWG22 STYLE 2095</td> <td>1.000</td> <td>M</td> </tr> <tr> <td>CE1735A0</td> <td>MINIFIT FEMALE END FITTING</td> <td>2.000</td> <td>PC</td> </tr> <tr> <td>CE1740A0</td> <td>MINIFIT MALE END FITTING</td> <td>2.000</td> <td>PC</td> </tr> <tr> <td>CE1745A0</td> <td>2 WAYS FEMALE MINIFIT CONNECTOR</td> <td>1.000</td> <td>PC</td> </tr> <tr> <td>CE1750A0</td> <td>3 WAYS MALE MINIFIT CONNECTOR</td> <td>1.000</td> <td>PC</td> </tr> <tr> <td>LP1044A0</td> <td>LUX LED BAR</td> <td>1.000</td> <td>PC</td> </tr> </tbody> </table>	Code	Description	Qty	UOM	CE1455A0	TIP END FITTING	2.000	PC	CE1730A0	PVC CABLE NP 2 X AWG22 STYLE 2095	1.000	M	CE1735A0	MINIFIT FEMALE END FITTING	2.000	PC	CE1740A0	MINIFIT MALE END FITTING	2.000	PC	CE1745A0	2 WAYS FEMALE MINIFIT CONNECTOR	1.000	PC	CE1750A0	3 WAYS MALE MINIFIT CONNECTOR	1.000	PC	LP1044A0	LUX LED BAR	1.000	PC																							
Code	Description	Qty	UOM																																																									
CE1455A0	TIP END FITTING	2.000	PC																																																									
CE1730A0	PVC CABLE NP 2 X AWG22 STYLE 2095	1.000	M																																																									
CE1735A0	MINIFIT FEMALE END FITTING	2.000	PC																																																									
CE1740A0	MINIFIT MALE END FITTING	2.000	PC																																																									
CE1745A0	2 WAYS FEMALE MINIFIT CONNECTOR	1.000	PC																																																									
CE1750A0	3 WAYS MALE MINIFIT CONNECTOR	1.000	PC																																																									
LP1044A0	LUX LED BAR	1.000	PC																																																									

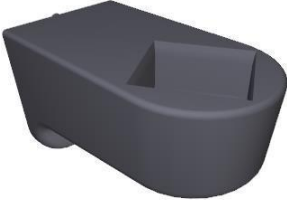

COMPONENT			SPARE PART																																							
Code	Description	Image	Code	Description	Kit components																																					
VM1621A	LED BAR UPPER SUPPORT		KLP1044A	LUX LED BAR KIT	<table border="1"> <thead> <tr> <th>Code</th> <th>Description</th> <th>Qty</th> <th>UOM</th> </tr> </thead> <tbody> <tr> <td>VM1620A0</td> <td>LED BAR LOWER SUPPORT</td> <td>1.000</td> <td>PC</td> </tr> <tr> <td>VM1621A0</td> <td>LED BAR UPPER SUPPORT</td> <td>1.000</td> <td>PC</td> </tr> </tbody> </table>	Code	Description	Qty	UOM	VM1620A0	LED BAR LOWER SUPPORT	1.000	PC	VM1621A0	LED BAR UPPER SUPPORT	1.000	PC																									
			Code	Description	Qty	UOM																																				
			VM1620A0	LED BAR LOWER SUPPORT	1.000	PC																																				
VM1621A0	LED BAR UPPER SUPPORT	1.000	PC																																							
KLP1007A	L200 LED BAR KIT	<table border="1"> <thead> <tr> <th>Code</th> <th>Description</th> <th>Qty</th> <th>UOM</th> </tr> </thead> <tbody> <tr> <td>CE1455A0</td> <td>TIP END FITTING</td> <td>2.000</td> <td>PC</td> </tr> <tr> <td>CE1730A0</td> <td>PVC CABLE NP 2 X AWG22 STYLE 2095</td> <td>1.000</td> <td>M</td> </tr> <tr> <td>CE1735A0</td> <td>MINIFIT FEMALE END FITTING</td> <td>2.000</td> <td>PC</td> </tr> <tr> <td>CE1740A0</td> <td>MINIFIT MALE END FITTING</td> <td>2.000</td> <td>PC</td> </tr> <tr> <td>CE1745A0</td> <td>2 WAYS FEMALE MINIFIT CONNECTOR</td> <td>1.000</td> <td>PC</td> </tr> <tr> <td>CE1750A0</td> <td>3 WAYS MALE MINIFIT CONNECTOR</td> <td>1.000</td> <td>PC</td> </tr> <tr> <td>LP1007A0</td> <td>LED LIGHT BAR L200</td> <td>1.000</td> <td>PC</td> </tr> <tr> <td>VM1620A0</td> <td>LED BAR LOWER SUPPORT</td> <td>1.000</td> <td>PC</td> </tr> <tr> <td>VM1621A0</td> <td>LED BAR UPPER SUPPORT</td> <td>1.000</td> <td>PC</td> </tr> </tbody> </table>	Code	Description	Qty	UOM	CE1455A0	TIP END FITTING	2.000	PC	CE1730A0	PVC CABLE NP 2 X AWG22 STYLE 2095	1.000	M	CE1735A0	MINIFIT FEMALE END FITTING	2.000	PC	CE1740A0	MINIFIT MALE END FITTING	2.000	PC	CE1745A0	2 WAYS FEMALE MINIFIT CONNECTOR	1.000	PC	CE1750A0	3 WAYS MALE MINIFIT CONNECTOR	1.000	PC	LP1007A0	LED LIGHT BAR L200	1.000	PC	VM1620A0	LED BAR LOWER SUPPORT	1.000	PC	VM1621A0	LED BAR UPPER SUPPORT	1.000	PC
Code	Description	Qty	UOM																																							
CE1455A0	TIP END FITTING	2.000	PC																																							
CE1730A0	PVC CABLE NP 2 X AWG22 STYLE 2095	1.000	M																																							
CE1735A0	MINIFIT FEMALE END FITTING	2.000	PC																																							
CE1740A0	MINIFIT MALE END FITTING	2.000	PC																																							
CE1745A0	2 WAYS FEMALE MINIFIT CONNECTOR	1.000	PC																																							
CE1750A0	3 WAYS MALE MINIFIT CONNECTOR	1.000	PC																																							
LP1007A0	LED LIGHT BAR L200	1.000	PC																																							
VM1620A0	LED BAR LOWER SUPPORT	1.000	PC																																							
VM1621A0	LED BAR UPPER SUPPORT	1.000	PC																																							
KLP1004B	L1000 LED BAR KIT	<table border="1"> <thead> <tr> <th>Code</th> <th>Description</th> <th>Qty</th> <th>UOM</th> </tr> </thead> <tbody> <tr> <td>CE1730A0</td> <td>PVC CABLE NP 2 X AWG22 STYLE 2095</td> <td>1.000</td> <td>M</td> </tr> <tr> <td>CE1735A0</td> <td>MINIFIT FEMALE END FITTING</td> <td>2.000</td> <td>PC</td> </tr> <tr> <td>CE1740A0</td> <td>MINIFIT MALE END FITTING</td> <td>2.000</td> <td>PC</td> </tr> <tr> <td>CE1745A0</td> <td>2 WAYS FEMALE MINIFIT CONNECTOR</td> <td>1.000</td> <td>PC</td> </tr> <tr> <td>CE1750A0</td> <td>3 WAYS MALE MINIFIT CONNECTOR</td> <td>1.000</td> <td>PC</td> </tr> <tr> <td>LP1004B0</td> <td>LEB LIGHTING BAR L1000</td> <td>1.000</td> <td>PC</td> </tr> <tr> <td>VM1620A0</td> <td>LED BAR LOWER SUPPORT</td> <td>1.000</td> <td>PC</td> </tr> <tr> <td>VM1621A0</td> <td>LED BAR UPPER SUPPORT</td> <td>1.000</td> <td>PC</td> </tr> </tbody> </table>	Code	Description	Qty	UOM	CE1730A0	PVC CABLE NP 2 X AWG22 STYLE 2095	1.000	M	CE1735A0	MINIFIT FEMALE END FITTING	2.000	PC	CE1740A0	MINIFIT MALE END FITTING	2.000	PC	CE1745A0	2 WAYS FEMALE MINIFIT CONNECTOR	1.000	PC	CE1750A0	3 WAYS MALE MINIFIT CONNECTOR	1.000	PC	LP1004B0	LEB LIGHTING BAR L1000	1.000	PC	VM1620A0	LED BAR LOWER SUPPORT	1.000	PC	VM1621A0	LED BAR UPPER SUPPORT	1.000	PC				
Code	Description	Qty	UOM																																							
CE1730A0	PVC CABLE NP 2 X AWG22 STYLE 2095	1.000	M																																							
CE1735A0	MINIFIT FEMALE END FITTING	2.000	PC																																							
CE1740A0	MINIFIT MALE END FITTING	2.000	PC																																							
CE1745A0	2 WAYS FEMALE MINIFIT CONNECTOR	1.000	PC																																							
CE1750A0	3 WAYS MALE MINIFIT CONNECTOR	1.000	PC																																							
LP1004B0	LEB LIGHTING BAR L1000	1.000	PC																																							
VM1620A0	LED BAR LOWER SUPPORT	1.000	PC																																							
VM1621A0	LED BAR UPPER SUPPORT	1.000	PC																																							







COMPONENT			SPARE PART																																										
Code	Description	Image	Code	Description	Kit components																																								
VM1621A	LED BAR UPPER SUPPORT		KLP1003B	2017 LED BAR KIT	<table border="1"> <thead> <tr> <th>Code</th> <th>Description</th> <th>Qty</th> <th>UOM</th> </tr> </thead> <tbody> <tr> <td>CE1730A0</td> <td>PVC CABLE NP 2 X AWG22 STYLE 2095</td> <td>1.000</td> <td>M</td> </tr> <tr> <td>CE1735A0</td> <td>MINIFIT FEMALE END FITTING</td> <td>2.000</td> <td>PC</td> </tr> <tr> <td>CE1740A0</td> <td>MINIFIT MALE END FITTING</td> <td>2.000</td> <td>PC</td> </tr> <tr> <td>CE1745A0</td> <td>2 WAYS FEMALE MINIFIT CONNECTOR</td> <td>1.000</td> <td>PC</td> </tr> <tr> <td>CE1750A0</td> <td>3 WAYS MALE MINIFIT CONNECTOR</td> <td>1.000</td> <td>PC</td> </tr> <tr> <td>LP1003B0</td> <td>LED LIGHT BAR L600</td> <td>1.000</td> <td>PC</td> </tr> <tr> <td>VM1620A0</td> <td>LED BAR LOWER SUPPORT</td> <td>1.000</td> <td>PC</td> </tr> <tr> <td>VM1621A0</td> <td>LED BAR UPPER SUPPORT</td> <td>1.000</td> <td>PC</td> </tr> <tr> <td>VM1794A0</td> <td>250x4.8 PA66 BLACK CLAMP</td> <td>2.000</td> <td>PC</td> </tr> </tbody> </table>	Code	Description	Qty	UOM	CE1730A0	PVC CABLE NP 2 X AWG22 STYLE 2095	1.000	M	CE1735A0	MINIFIT FEMALE END FITTING	2.000	PC	CE1740A0	MINIFIT MALE END FITTING	2.000	PC	CE1745A0	2 WAYS FEMALE MINIFIT CONNECTOR	1.000	PC	CE1750A0	3 WAYS MALE MINIFIT CONNECTOR	1.000	PC	LP1003B0	LED LIGHT BAR L600	1.000	PC	VM1620A0	LED BAR LOWER SUPPORT	1.000	PC	VM1621A0	LED BAR UPPER SUPPORT	1.000	PC	VM1794A0	250x4.8 PA66 BLACK CLAMP	2.000	PC
			Code	Description	Qty	UOM																																							
CE1730A0	PVC CABLE NP 2 X AWG22 STYLE 2095	1.000	M																																										
CE1735A0	MINIFIT FEMALE END FITTING	2.000	PC																																										
CE1740A0	MINIFIT MALE END FITTING	2.000	PC																																										
CE1745A0	2 WAYS FEMALE MINIFIT CONNECTOR	1.000	PC																																										
CE1750A0	3 WAYS MALE MINIFIT CONNECTOR	1.000	PC																																										
LP1003B0	LED LIGHT BAR L600	1.000	PC																																										
VM1620A0	LED BAR LOWER SUPPORT	1.000	PC																																										
VM1621A0	LED BAR UPPER SUPPORT	1.000	PC																																										
VM1794A0	250x4.8 PA66 BLACK CLAMP	2.000	PC																																										
KLP1002B	L400 LED BAR KIT	<table border="1"> <thead> <tr> <th>Code</th> <th>Description</th> <th>Qty</th> <th>UOM</th> </tr> </thead> <tbody> <tr> <td>CE1455A0</td> <td>TIP END FITTING</td> <td>2.000</td> <td>PC</td> </tr> <tr> <td>CE1730A0</td> <td>PVC CABLE NP 2 X AWG22 STYLE 2095</td> <td>1.000</td> <td>M</td> </tr> <tr> <td>CE1735A0</td> <td>MINIFIT FEMALE END FITTING</td> <td>2.000</td> <td>PC</td> </tr> <tr> <td>CE1740A0</td> <td>MINIFIT MALE END FITTING</td> <td>2.000</td> <td>PC</td> </tr> <tr> <td>CE1745A0</td> <td>2 WAYS FEMALE MINIFIT CONNECTOR</td> <td>1.000</td> <td>PC</td> </tr> <tr> <td>CE1750A0</td> <td>3 WAYS MALE MINIFIT CONNECTOR</td> <td>1.000</td> <td>PC</td> </tr> <tr> <td>LP1002B0</td> <td>LED LIGHTING BAR L400</td> <td>1.000</td> <td>PC</td> </tr> <tr> <td>VM1620A0</td> <td>LED BAR LOWER SUPPORT</td> <td>1.000</td> <td>PC</td> </tr> <tr> <td>VM1621A0</td> <td>LED BAR UPPER SUPPORT</td> <td>1.000</td> <td>PC</td> </tr> </tbody> </table>	Code	Description	Qty	UOM	CE1455A0	TIP END FITTING	2.000	PC	CE1730A0	PVC CABLE NP 2 X AWG22 STYLE 2095	1.000	M	CE1735A0	MINIFIT FEMALE END FITTING	2.000	PC	CE1740A0	MINIFIT MALE END FITTING	2.000	PC	CE1745A0	2 WAYS FEMALE MINIFIT CONNECTOR	1.000	PC	CE1750A0	3 WAYS MALE MINIFIT CONNECTOR	1.000	PC	LP1002B0	LED LIGHTING BAR L400	1.000	PC	VM1620A0	LED BAR LOWER SUPPORT	1.000	PC	VM1621A0	LED BAR UPPER SUPPORT	1.000	PC			
Code	Description	Qty	UOM																																										
CE1455A0	TIP END FITTING	2.000	PC																																										
CE1730A0	PVC CABLE NP 2 X AWG22 STYLE 2095	1.000	M																																										
CE1735A0	MINIFIT FEMALE END FITTING	2.000	PC																																										
CE1740A0	MINIFIT MALE END FITTING	2.000	PC																																										
CE1745A0	2 WAYS FEMALE MINIFIT CONNECTOR	1.000	PC																																										
CE1750A0	3 WAYS MALE MINIFIT CONNECTOR	1.000	PC																																										
LP1002B0	LED LIGHTING BAR L400	1.000	PC																																										
VM1620A0	LED BAR LOWER SUPPORT	1.000	PC																																										
VM1621A0	LED BAR UPPER SUPPORT	1.000	PC																																										







COMPONENT			SPARE PART																																																													
Code	Description	Image	Code	Description	Kit components																																																											
VM1621A	LED BAR UPPER SUPPORT		KLP1001B	L300 LED BAR KIT	<table border="1"> <thead> <tr> <th>Code</th> <th>Description</th> <th>Qty</th> <th>UOM</th> </tr> </thead> <tbody> <tr> <td>CE1455A0</td> <td>TIP END FITTING</td> <td>2.000</td> <td>PC</td> </tr> <tr> <td>CE1730A0</td> <td>PVC CABLE NP 2 X AWG22 STYLE 2095</td> <td>1.000</td> <td>M</td> </tr> <tr> <td>CE1735A0</td> <td>MINIFIT FEMALE END FITTING</td> <td>2.000</td> <td>PC</td> </tr> <tr> <td>CE1740A0</td> <td>MINIFIT MALE END FITTING</td> <td>2.000</td> <td>PC</td> </tr> <tr> <td>CE1745A0</td> <td>2 WAYS FEMALE MINIFIT CONNECTOR</td> <td>1.000</td> <td>PC</td> </tr> <tr> <td>CE1750A0</td> <td>3 WAYS MALE MINIFIT CONNECTOR</td> <td>1.000</td> <td>PC</td> </tr> <tr> <td>LP1001B0</td> <td>LED LIGHTING BAR L300</td> <td>1.000</td> <td>PC</td> </tr> <tr> <td>VM1620A0</td> <td>LED BAR LOWER SUPPORT</td> <td>1.000</td> <td>PC</td> </tr> <tr> <td>VM1621A0</td> <td>LED BAR UPPER SUPPORT</td> <td>1.000</td> <td>PC</td> </tr> </tbody> </table>	Code	Description	Qty	UOM	CE1455A0	TIP END FITTING	2.000	PC	CE1730A0	PVC CABLE NP 2 X AWG22 STYLE 2095	1.000	M	CE1735A0	MINIFIT FEMALE END FITTING	2.000	PC	CE1740A0	MINIFIT MALE END FITTING	2.000	PC	CE1745A0	2 WAYS FEMALE MINIFIT CONNECTOR	1.000	PC	CE1750A0	3 WAYS MALE MINIFIT CONNECTOR	1.000	PC	LP1001B0	LED LIGHTING BAR L300	1.000	PC	VM1620A0	LED BAR LOWER SUPPORT	1.000	PC	VM1621A0	LED BAR UPPER SUPPORT	1.000	PC	KLP1000A	L100 LED BAR KIT	<table border="1"> <thead> <tr> <th>Code</th> <th>Description</th> <th>Qty</th> <th>UOM</th> </tr> </thead> <tbody> <tr> <td>LP1000A0</td> <td>LED LIGHTING BAR L100</td> <td>1.000</td> <td>PC</td> </tr> <tr> <td>VM1620A0</td> <td>LED BAR LOWER SUPPORT</td> <td>1.000</td> <td>PC</td> </tr> <tr> <td>VM1621A0</td> <td>LED BAR UPPER SUPPORT</td> <td>1.000</td> <td>PC</td> </tr> </tbody> </table>	Code	Description	Qty	UOM	LP1000A0	LED LIGHTING BAR L100	1.000	PC	VM1620A0	LED BAR LOWER SUPPORT	1.000	PC	VM1621A0	LED BAR UPPER SUPPORT	1.000	PC
			Code	Description	Qty	UOM																																																										
CE1455A0	TIP END FITTING	2.000	PC																																																													
CE1730A0	PVC CABLE NP 2 X AWG22 STYLE 2095	1.000	M																																																													
CE1735A0	MINIFIT FEMALE END FITTING	2.000	PC																																																													
CE1740A0	MINIFIT MALE END FITTING	2.000	PC																																																													
CE1745A0	2 WAYS FEMALE MINIFIT CONNECTOR	1.000	PC																																																													
CE1750A0	3 WAYS MALE MINIFIT CONNECTOR	1.000	PC																																																													
LP1001B0	LED LIGHTING BAR L300	1.000	PC																																																													
VM1620A0	LED BAR LOWER SUPPORT	1.000	PC																																																													
VM1621A0	LED BAR UPPER SUPPORT	1.000	PC																																																													
Code	Description	Qty	UOM																																																													
LP1000A0	LED LIGHTING BAR L100	1.000	PC																																																													
VM1620A0	LED BAR LOWER SUPPORT	1.000	PC																																																													
VM1621A0	LED BAR UPPER SUPPORT	1.000	PC																																																													
MG1030B	CT-BT DOOR HANDL		KMG1030B	CT-BT-CLUX-BLUX HANDLE KIT	<table border="1"> <thead> <tr> <th>Code</th> <th>Description</th> <th>Qty</th> <th>UOM</th> </tr> </thead> <tbody> <tr> <td>MG1030B2</td> <td>CT-BT DOOR HANDLE</td> <td>1.000</td> <td>PC</td> </tr> <tr> <td>VI1074A0</td> <td>4X16 SCREW FOR PLASTIC</td> <td>4.000</td> <td>PC</td> </tr> <tr> <td>VM1490A0</td> <td>CHEFTOP/BAK ERTOP HANDLE SCREWS COVER</td> <td>2.000</td> <td>PC</td> </tr> </tbody> </table>	Code	Description	Qty	UOM	MG1030B2	CT-BT DOOR HANDLE	1.000	PC	VI1074A0	4X16 SCREW FOR PLASTIC	4.000	PC	VM1490A0	CHEFTOP/BAK ERTOP HANDLE SCREWS COVER	2.000	PC																																											
Code	Description	Qty	UOM																																																													
MG1030B2	CT-BT DOOR HANDLE	1.000	PC																																																													
VI1074A0	4X16 SCREW FOR PLASTIC	4.000	PC																																																													
VM1490A0	CHEFTOP/BAK ERTOP HANDLE SCREWS COVER	2.000	PC																																																													





COMPONENT			SPARE PART										
Code	Description	Image	Code	Description	Kit components								
TB2778A	CHEFLUX DOOR UPPER LISTEL		TB2778A0	CHEFLUX DOOR UPPER LISTEL									
TB2779A	CHEFLUX DOOR LOWER LISTEL		TB2779A0	CHEFLUX DOOR LOWER LISTEL									
TB3097A	CHEFLUX XV393 DOOR RIGHT COLUMN		TB3097A0	CHEFLUX XV393 DOOR RIGHT COLUMN									
VM1170B	UPPER DOOR FULCRUM CAP		KVM1170B	UPPER DOOR FULCRUM CAP KIT	<table border="1"> <thead> <tr> <th>Code</th> <th>Description</th> <th>Qty</th> <th>UOM</th> </tr> </thead> <tbody> <tr> <td>VM1170B0</td> <td>UPPER DOOR FULCRUM CA</td> <td>2.000</td> <td>PC</td> </tr> </tbody> </table>	Code	Description	Qty	UOM	VM1170B0	UPPER DOOR FULCRUM CA	2.000	PC
Code	Description	Qty	UOM										
VM1170B0	UPPER DOOR FULCRUM CA	2.000	PC										
VM1171B	DOOR LOWER FULCRUM CAP		KVM1171B	LOWER DOOR FULCRUM CAP KIT	<table border="1"> <thead> <tr> <th>Code</th> <th>Description</th> <th>Qty</th> <th>UOM</th> </tr> </thead> <tbody> <tr> <td>VM1171B0</td> <td>DOOR LOWER FULCRUM CA</td> <td>2.000</td> <td>PC</td> </tr> </tbody> </table>	Code	Description	Qty	UOM	VM1171B0	DOOR LOWER FULCRUM CA	2.000	PC
Code	Description	Qty	UOM										
VM1171B0	DOOR LOWER FULCRUM CA	2.000	PC										



COMPONENT			SPARE PART																		
Code	Description	Image	Code	Description	Kit components																
VM1510A	XBC/XVC GROOVED DOOR PIN BUSHING		KVM1510A	GROOVED DOOR PIN BUSHING 5 PCS KIT	<table border="1"> <thead> <tr> <th>Code</th> <th>Description</th> <th>Qty</th> <th>UOM</th> </tr> </thead> <tbody> <tr> <td>VM1510A0</td> <td>XBC/XVC GROOVED DOOR PIN BUSHING</td> <td>5.000</td> <td>PC</td> </tr> </tbody> </table>	Code	Description	Qty	UOM	VM1510A0	XBC/XVC GROOVED DOOR PIN BUSHING	5.000	PC								
Code	Description	Qty	UOM																		
VM1510A0	XBC/XVC GROOVED DOOR PIN BUSHING	5.000	PC																		
VM1511A	XBC/XVC SLEEK DOOR PIN BUSHING		KVM1511A	5 PCS SLEEK DOOR PIN BUSHING KIT	<table border="1"> <thead> <tr> <th>Code</th> <th>Description</th> <th>Qty</th> <th>UOM</th> </tr> </thead> <tbody> <tr> <td>VM1511A0</td> <td>XBC/XVC SLEEK DOOR PIN BUSHING</td> <td>5.000</td> <td>PC</td> </tr> </tbody> </table>	Code	Description	Qty	UOM	VM1511A0	XBC/XVC SLEEK DOOR PIN BUSHING	5.000	PC								
Code	Description	Qty	UOM																		
VM1511A0	XBC/XVC SLEEK DOOR PIN BUSHING	5.000	PC																		
VM1680A	INTERNAL GLASS HINGE		KVM1680A	INTERNAL GLASS HINGE SUPPORT 2 PCS KIT	<table border="1"> <thead> <tr> <th>Code</th> <th>Description</th> <th>Qty</th> <th>UOM</th> </tr> </thead> <tbody> <tr> <td>V11300A0</td> <td>SCREW M6X12 T1/2T+INOX</td> <td>4.000</td> <td>PC</td> </tr> <tr> <td>VM1680A0</td> <td>INTERNAL GLASS HINGE</td> <td>2.000</td> <td>PC</td> </tr> </tbody> </table>	Code	Description	Qty	UOM	V11300A0	SCREW M6X12 T1/2T+INOX	4.000	PC	VM1680A0	INTERNAL GLASS HINGE	2.000	PC				
Code	Description	Qty	UOM																		
V11300A0	SCREW M6X12 T1/2T+INOX	4.000	PC																		
VM1680A0	INTERNAL GLASS HINGE	2.000	PC																		
VM1976A	CL BL DOOR COLUMN BLANKING CAP		KVM1976A	CL BL DOOR COLUMN BLANKING CAP KIT	<table border="1"> <thead> <tr> <th>Code</th> <th>Description</th> <th>Qty</th> <th>UOM</th> </tr> </thead> <tbody> <tr> <td>VM1976A0</td> <td>CL BL DOOR COLUMN BLANKING CA</td> <td>1.000</td> <td>PC</td> </tr> </tbody> </table>	Code	Description	Qty	UOM	VM1976A0	CL BL DOOR COLUMN BLANKING CA	1.000	PC								
Code	Description	Qty	UOM																		
VM1976A0	CL BL DOOR COLUMN BLANKING CA	1.000	PC																		
VM2042A	INTERNAL GLASS LATERAL LOCKING SYSTEM		KVM2042A	INTERNAL GLASS SPRING STOPPER KIT	<table border="1"> <thead> <tr> <th>Code</th> <th>Description</th> <th>Qty</th> <th>UOM</th> </tr> </thead> <tbody> <tr> <td>RC1200A0</td> <td>ED=4 WIRE D=0.5 H24 COMPRESSIO N SPRING</td> <td>2.000</td> <td>PC</td> </tr> <tr> <td>V11220A1</td> <td>4,2x12 TCB SELF-TAPPIN G SCREW</td> <td>2.000</td> <td>PC</td> </tr> <tr> <td>VM2042A0</td> <td>INTERNAL GLASS LATERAL LOCKING SYSTEM</td> <td>1.000</td> <td>PC</td> </tr> </tbody> </table>	Code	Description	Qty	UOM	RC1200A0	ED=4 WIRE D=0.5 H24 COMPRESSIO N SPRING	2.000	PC	V11220A1	4,2x12 TCB SELF-TAPPIN G SCREW	2.000	PC	VM2042A0	INTERNAL GLASS LATERAL LOCKING SYSTEM	1.000	PC
Code	Description	Qty	UOM																		
RC1200A0	ED=4 WIRE D=0.5 H24 COMPRESSIO N SPRING	2.000	PC																		
V11220A1	4,2x12 TCB SELF-TAPPIN G SCREW	2.000	PC																		
VM2042A0	INTERNAL GLASS LATERAL LOCKING SYSTEM	1.000	PC																		



COMPONENT			SPARE PART																										
Code	Description	Image	Code	Description	Kit components																								
VM2043A	UPPER - LOWER GLASS SUPPORT		KVM2043A	UPPER - LOWER GLASS SUPPORT 2 PCS KIT	<table border="1"> <thead> <tr> <th>Code</th> <th>Description</th> <th>Qty</th> <th>UOM</th> </tr> </thead> <tbody> <tr> <td>VM2043A0</td> <td>UPPER - LOWER GLASS SUPPORT</td> <td>2.000</td> <td>PC</td> </tr> </tbody> </table>	Code	Description	Qty	UOM	VM2043A0	UPPER - LOWER GLASS SUPPORT	2.000	PC																
Code	Description	Qty	UOM																										
VM2043A0	UPPER - LOWER GLASS SUPPORT	2.000	PC																										
VT1272A	CHEFLUX XV393 EXTERNAL BLACK GLASS		KVT1272AR	XV393 LED EXTERNAL GLASS KIT	<table border="1"> <thead> <tr> <th>Code</th> <th>Description</th> <th>Qty</th> <th>UOM</th> </tr> </thead> <tbody> <tr> <td>0H7531A0</td> <td>XV393 EXTERNAL GLASS HOLDING PROFILE</td> <td>2.000</td> <td>PC</td> </tr> <tr> <td>SL1155A1</td> <td>LOCTITE BICOMPONEN T SILICON</td> <td>0.160</td> <td>ML</td> </tr> <tr> <td>SL1158A0</td> <td>NOZZLE FOR WHITE SILICON GUN</td> <td>1.000</td> <td>PC</td> </tr> </tbody> </table>	Code	Description	Qty	UOM	0H7531A0	XV393 EXTERNAL GLASS HOLDING PROFILE	2.000	PC	SL1155A1	LOCTITE BICOMPONEN T SILICON	0.160	ML	SL1158A0	NOZZLE FOR WHITE SILICON GUN	1.000	PC								
					Code	Description	Qty	UOM																					
					0H7531A0	XV393 EXTERNAL GLASS HOLDING PROFILE	2.000	PC																					
					SL1155A1	LOCTITE BICOMPONEN T SILICON	0.160	ML																					
			SL1158A0	NOZZLE FOR WHITE SILICON GUN	1.000	PC																							
			KVT1272A	XV393 EXTERNAL GLASS KIT	<table border="1"> <thead> <tr> <th>Code</th> <th>Description</th> <th>Qty</th> <th>UOM</th> </tr> </thead> <tbody> <tr> <td>VT1272A0</td> <td>CHEFLUX XV393 EXTERNAL BLACK GLASS</td> <td>1.000</td> <td>PC</td> </tr> <tr> <td>0H7105A0</td> <td>XV393 EXTERNAL GLASS HOLDING PROFILE</td> <td>2.000</td> <td>PC</td> </tr> <tr> <td>SL1155A1</td> <td>LOCTITE BICOMPONEN T SILICON</td> <td>0.160</td> <td>ML</td> </tr> <tr> <td>SL1158A0</td> <td>NOZZLE FOR WHITE SILICON GUN</td> <td>1.000</td> <td>PC</td> </tr> <tr> <td>VT1272A0</td> <td>CHEFLUX XV393 EXTERNAL BLACK GLASS</td> <td>1.000</td> <td>PC</td> </tr> </tbody> </table>	Code	Description	Qty	UOM	VT1272A0	CHEFLUX XV393 EXTERNAL BLACK GLASS	1.000	PC	0H7105A0	XV393 EXTERNAL GLASS HOLDING PROFILE	2.000	PC	SL1155A1	LOCTITE BICOMPONEN T SILICON	0.160	ML	SL1158A0	NOZZLE FOR WHITE SILICON GUN	1.000	PC	VT1272A0	CHEFLUX XV393 EXTERNAL BLACK GLASS	1.000	PC
					Code	Description	Qty	UOM																					
					VT1272A0	CHEFLUX XV393 EXTERNAL BLACK GLASS	1.000	PC																					
					0H7105A0	XV393 EXTERNAL GLASS HOLDING PROFILE	2.000	PC																					
					SL1155A1	LOCTITE BICOMPONEN T SILICON	0.160	ML																					
SL1158A0	NOZZLE FOR WHITE SILICON GUN	1.000			PC																								
VT1272A0	CHEFLUX XV393 EXTERNAL BLACK GLASS	1.000	PC																										
KDR1268AR	XV393 LED COMPLETE DOOR	<table border="1"> <thead> <tr> <th>Code</th> <th>Description</th> <th>Qty</th> <th>UOM</th> </tr> </thead> <tbody> <tr> <td>0H7531A0</td> <td>XV393 EXTERNAL GLASS HOLDING PROFILE</td> <td>2.000</td> <td>PC</td> </tr> <tr> <td>CE1820A0</td> <td>2P-800-AMPM ODU2-2P MINIFIT CABLE</td> <td>1.000</td> <td>PC</td> </tr> </tbody> </table>	Code	Description	Qty	UOM	0H7531A0	XV393 EXTERNAL GLASS HOLDING PROFILE	2.000	PC	CE1820A0	2P-800-AMPM ODU2-2P MINIFIT CABLE	1.000	PC															
		Code	Description	Qty	UOM																								
0H7531A0	XV393 EXTERNAL GLASS HOLDING PROFILE	2.000	PC																										
CE1820A0	2P-800-AMPM ODU2-2P MINIFIT CABLE	1.000	PC																										



COMPONENT			SPARE PART																																																																																						
Code	Description	Image	Code	Description	Kit components																																																																																				
VT1272A	CHEFLUX XV393 EXTERNAL BLACK GLASS		KDR1268AR	XV393 LED COMPLETE DOOR	<table border="1"> <thead> <tr> <th>Code</th> <th>Description</th> <th>Qty</th> <th>UOM</th> </tr> </thead> <tbody> <tr> <td>CE1823A1</td> <td>LUX LED BAR EXTENSION CORD</td> <td>1.000</td> <td>PC</td> </tr> <tr> <td>CR1085A0</td> <td>INTERNAL GLASS UPPER HINGE</td> <td>1.000</td> <td>PC</td> </tr> <tr> <td>CR1086A0</td> <td>INTERNAL GLASS LOWER HINGE</td> <td>1.000</td> <td>PC</td> </tr> <tr> <td>GN1181A0</td> <td>INTERNAL GLASS HINGE SEAL</td> <td>2.000</td> <td>PC</td> </tr> <tr> <td>LP1044A0</td> <td>LUX LED BAR</td> <td>1.000</td> <td>PC</td> </tr> <tr> <td>MG1030B2</td> <td>CT-BT DOOR HANDLE</td> <td>1.000</td> <td>PC</td> </tr> <tr> <td>TB2778A0</td> <td>CHEFLUX DOOR UPPER LISTEL</td> <td>1.000</td> <td>PC</td> </tr> <tr> <td>TB2779A0</td> <td>CHEFLUX DOOR LOWER LISTEL</td> <td>1.000</td> <td>PC</td> </tr> <tr> <td>TB3094A0</td> <td>CHEFLUX XV393 DOOR LEFT COLUMN</td> <td>1.000</td> <td>PC</td> </tr> <tr> <td>TB3097A0</td> <td>CHEFLUX XV393 DOOR RIGHT COLUM</td> <td>1.000</td> <td>PC</td> </tr> <tr> <td>VI1074A0</td> <td>4X16 SCREW FOR PLASTIC</td> <td>4.000</td> <td>PC</td> </tr> <tr> <td>VI1075A0</td> <td>NUT M4 H=4 UNI5587 INOX</td> <td>1.000</td> <td>PC</td> </tr> <tr> <td>VI1220A1</td> <td>4,2x12 TCB SELF-TAPPIN G SCREW</td> <td>18.000</td> <td>PC</td> </tr> <tr> <td>VI1300A0</td> <td>SCREW M6X12 T1/2T+INOX</td> <td>12.000</td> <td>PC</td> </tr> <tr> <td>VI1310A0</td> <td>ZINC THREAD INSERT M6 FTR/E</td> <td>8.000</td> <td>PC</td> </tr> <tr> <td>VI1340A0</td> <td>M6 ST. STEEL THREADED INSERT</td> <td>4.000</td> <td>PC</td> </tr> <tr> <td>VI1810A0</td> <td>M6X6 STAINLESS STEEL FLATHEAD SCREW</td> <td>6.000</td> <td>PC</td> </tr> <tr> <td>VI1950A0</td> <td>ST. STEEL 4,2X13 TCB SELF-DRILLIN G SCREW</td> <td>4.000</td> <td>PC</td> </tr> <tr> <td>VM1170B0</td> <td>UPPER DOOR FULCRUM CA</td> <td>1.000</td> <td>PC</td> </tr> <tr> <td>VM1171B0</td> <td>DOOR LOWER FULCRUM CA</td> <td>1.000</td> <td>PC</td> </tr> </tbody> </table>	Code	Description	Qty	UOM	CE1823A1	LUX LED BAR EXTENSION CORD	1.000	PC	CR1085A0	INTERNAL GLASS UPPER HINGE	1.000	PC	CR1086A0	INTERNAL GLASS LOWER HINGE	1.000	PC	GN1181A0	INTERNAL GLASS HINGE SEAL	2.000	PC	LP1044A0	LUX LED BAR	1.000	PC	MG1030B2	CT-BT DOOR HANDLE	1.000	PC	TB2778A0	CHEFLUX DOOR UPPER LISTEL	1.000	PC	TB2779A0	CHEFLUX DOOR LOWER LISTEL	1.000	PC	TB3094A0	CHEFLUX XV393 DOOR LEFT COLUMN	1.000	PC	TB3097A0	CHEFLUX XV393 DOOR RIGHT COLUM	1.000	PC	VI1074A0	4X16 SCREW FOR PLASTIC	4.000	PC	VI1075A0	NUT M4 H=4 UNI5587 INOX	1.000	PC	VI1220A1	4,2x12 TCB SELF-TAPPIN G SCREW	18.000	PC	VI1300A0	SCREW M6X12 T1/2T+INOX	12.000	PC	VI1310A0	ZINC THREAD INSERT M6 FTR/E	8.000	PC	VI1340A0	M6 ST. STEEL THREADED INSERT	4.000	PC	VI1810A0	M6X6 STAINLESS STEEL FLATHEAD SCREW	6.000	PC	VI1950A0	ST. STEEL 4,2X13 TCB SELF-DRILLIN G SCREW	4.000	PC	VM1170B0	UPPER DOOR FULCRUM CA	1.000	PC	VM1171B0	DOOR LOWER FULCRUM CA	1.000	PC
Code	Description	Qty	UOM																																																																																						
CE1823A1	LUX LED BAR EXTENSION CORD	1.000	PC																																																																																						
CR1085A0	INTERNAL GLASS UPPER HINGE	1.000	PC																																																																																						
CR1086A0	INTERNAL GLASS LOWER HINGE	1.000	PC																																																																																						
GN1181A0	INTERNAL GLASS HINGE SEAL	2.000	PC																																																																																						
LP1044A0	LUX LED BAR	1.000	PC																																																																																						
MG1030B2	CT-BT DOOR HANDLE	1.000	PC																																																																																						
TB2778A0	CHEFLUX DOOR UPPER LISTEL	1.000	PC																																																																																						
TB2779A0	CHEFLUX DOOR LOWER LISTEL	1.000	PC																																																																																						
TB3094A0	CHEFLUX XV393 DOOR LEFT COLUMN	1.000	PC																																																																																						
TB3097A0	CHEFLUX XV393 DOOR RIGHT COLUM	1.000	PC																																																																																						
VI1074A0	4X16 SCREW FOR PLASTIC	4.000	PC																																																																																						
VI1075A0	NUT M4 H=4 UNI5587 INOX	1.000	PC																																																																																						
VI1220A1	4,2x12 TCB SELF-TAPPIN G SCREW	18.000	PC																																																																																						
VI1300A0	SCREW M6X12 T1/2T+INOX	12.000	PC																																																																																						
VI1310A0	ZINC THREAD INSERT M6 FTR/E	8.000	PC																																																																																						
VI1340A0	M6 ST. STEEL THREADED INSERT	4.000	PC																																																																																						
VI1810A0	M6X6 STAINLESS STEEL FLATHEAD SCREW	6.000	PC																																																																																						
VI1950A0	ST. STEEL 4,2X13 TCB SELF-DRILLIN G SCREW	4.000	PC																																																																																						
VM1170B0	UPPER DOOR FULCRUM CA	1.000	PC																																																																																						
VM1171B0	DOOR LOWER FULCRUM CA	1.000	PC																																																																																						



COMPONENT			SPARE PART																																																																									
Code	Description	Image	Code	Description	Kit components																																																																							
VT1272A	CHEFLUX XV393 EXTERNAL BLACK GLASS		KDR1268AR	XV393 LED COMPLETE DOOR	<table border="1"> <thead> <tr> <th>Code</th> <th>Description</th> <th>Qty</th> <th>UOM</th> </tr> </thead> <tbody> <tr> <td>VM1490A0</td> <td>CHEFTOP/BAK ERTOP HANDLE SCREWS COVER</td> <td>2.000</td> <td>PC</td> </tr> <tr> <td>VM1510A0</td> <td>XBC/XVC GROOVED DOOR PIN BUSHING</td> <td>1.000</td> <td>PC</td> </tr> <tr> <td>VM1511A0</td> <td>XBC/XVC SLEEK DOOR PIN BUSHING</td> <td>1.000</td> <td>PC</td> </tr> <tr> <td>VM1591A0</td> <td>GLASS BRACKET INT. XVC1004</td> <td>1.000</td> <td>PC</td> </tr> <tr> <td>VM1620A0</td> <td>LED BAR LOWER SUPPORT</td> <td>1.000</td> <td>PC</td> </tr> <tr> <td>VM1621A0</td> <td>LED BAR UPPER SUPPORT</td> <td>1.000</td> <td>PC</td> </tr> <tr> <td>VM1630A1</td> <td>INTERNAL GLASS PUSHING CAP</td> <td>2.000</td> <td>PC</td> </tr> <tr> <td>VM1680A0</td> <td>INTERNAL GLASS HINGE</td> <td>2.000</td> <td>PC</td> </tr> <tr> <td>VM1976A0</td> <td>CL BL DOOR COLUMN BLANKING CA</td> <td>2.000</td> <td>PC</td> </tr> <tr> <td>VM2008A0</td> <td>SPACER FOR MICROSWITC</td> <td>1.000</td> <td>PC</td> </tr> <tr> <td>VM2042A0</td> <td>INTERNAL GLASS LATERAL LOCKING SYSTEM</td> <td>2.000</td> <td>PC</td> </tr> <tr> <td>VM2043A0</td> <td>UPPER - LOWER GLASS SUPPORT</td> <td>2.000</td> <td>PC</td> </tr> <tr> <td>VT1095A0</td> <td>XL375/XV393/X VC304-305 INNER GLASS</td> <td>1.000</td> <td>PC</td> </tr> <tr> <td>VT1272A0</td> <td>CHEFLUX XV393 EXTERNAL BLACK GLASS</td> <td>1.000</td> <td>PC</td> </tr> </tbody> </table>	Code	Description	Qty	UOM	VM1490A0	CHEFTOP/BAK ERTOP HANDLE SCREWS COVER	2.000	PC	VM1510A0	XBC/XVC GROOVED DOOR PIN BUSHING	1.000	PC	VM1511A0	XBC/XVC SLEEK DOOR PIN BUSHING	1.000	PC	VM1591A0	GLASS BRACKET INT. XVC1004	1.000	PC	VM1620A0	LED BAR LOWER SUPPORT	1.000	PC	VM1621A0	LED BAR UPPER SUPPORT	1.000	PC	VM1630A1	INTERNAL GLASS PUSHING CAP	2.000	PC	VM1680A0	INTERNAL GLASS HINGE	2.000	PC	VM1976A0	CL BL DOOR COLUMN BLANKING CA	2.000	PC	VM2008A0	SPACER FOR MICROSWITC	1.000	PC	VM2042A0	INTERNAL GLASS LATERAL LOCKING SYSTEM	2.000	PC	VM2043A0	UPPER - LOWER GLASS SUPPORT	2.000	PC	VT1095A0	XL375/XV393/X VC304-305 INNER GLASS	1.000	PC	VT1272A0	CHEFLUX XV393 EXTERNAL BLACK GLASS	1.000	PC	KDR1268A	XV393 COMPLETE DOOR	<table border="1"> <thead> <tr> <th>Code</th> <th>Description</th> <th>Qty</th> <th>UOM</th> </tr> </thead> <tbody> <tr> <td>0H7105A0</td> <td>XV393 EXTERNAL GLASS HOLDING PROFILE</td> <td>2.000</td> <td>PC</td> </tr> </tbody> </table>	Code	Description	Qty	UOM	0H7105A0	XV393 EXTERNAL GLASS HOLDING PROFILE	2.000	PC
			Code	Description	Qty	UOM																																																																						
VM1490A0	CHEFTOP/BAK ERTOP HANDLE SCREWS COVER	2.000	PC																																																																									
VM1510A0	XBC/XVC GROOVED DOOR PIN BUSHING	1.000	PC																																																																									
VM1511A0	XBC/XVC SLEEK DOOR PIN BUSHING	1.000	PC																																																																									
VM1591A0	GLASS BRACKET INT. XVC1004	1.000	PC																																																																									
VM1620A0	LED BAR LOWER SUPPORT	1.000	PC																																																																									
VM1621A0	LED BAR UPPER SUPPORT	1.000	PC																																																																									
VM1630A1	INTERNAL GLASS PUSHING CAP	2.000	PC																																																																									
VM1680A0	INTERNAL GLASS HINGE	2.000	PC																																																																									
VM1976A0	CL BL DOOR COLUMN BLANKING CA	2.000	PC																																																																									
VM2008A0	SPACER FOR MICROSWITC	1.000	PC																																																																									
VM2042A0	INTERNAL GLASS LATERAL LOCKING SYSTEM	2.000	PC																																																																									
VM2043A0	UPPER - LOWER GLASS SUPPORT	2.000	PC																																																																									
VT1095A0	XL375/XV393/X VC304-305 INNER GLASS	1.000	PC																																																																									
VT1272A0	CHEFLUX XV393 EXTERNAL BLACK GLASS	1.000	PC																																																																									
Code	Description	Qty	UOM																																																																									
0H7105A0	XV393 EXTERNAL GLASS HOLDING PROFILE	2.000	PC																																																																									



COMPONENT			SPARE PART					
Code	Description	Image	Code	Description	Kit components			
VT1272A	CHEFLUX XV393 EXTERNAL BLACK GLASS		KDR1268A	XV393 COMPLETE DOOR	Code	Description	Qty	UOM
					CR1085A0	INTERNAL GLASS UPPER HINGE	1.000	PC
					CR1086A0	INTERNAL GLASS LOWER HINGE	1.000	PC
					GN1181A0	INTERNAL GLASS HINGE SEAL	2.000	PC
					MG1030B2	CT-BT DOOR HANDLE	1.000	PC
					TB2776A0	CHEFLUX XV393 DOOR RIGHT COLUM	1.000	PC
					TB2777A0	CHEFLUX XV393 DOOR LEFT COLUMN	1.000	PC
					TB2778A0	CHEFLUX DOOR UPPER LISTEL	1.000	PC
					TB2779A0	CHEFLUX DOOR LOWER LISTEL	1.000	PC
					VI1070A0	SCREW M4x16 TSP/UNI7688 INOX	1.000	PC
					VI1074A0	4X16 SCREW FOR PLASTIC	4.000	PC
					VI1075A0	NUT M4 H=4 UNI5587 INOX	1.000	PC
					VI1220A1	4,2x12 TCB SELF-TAPPIN G SCREW	18.000	PC
					VI1300A0	SCREW M6X12 T1/2T+INOX	12.000	PC
					VI1310A0	ZINC THREAD INSERT M6 FTR/E	8.000	PC
					VI1340A0	M6 ST. STEEL THREADED INSERT	4.000	PC
					VI1810A0	M6X6 STAINLESS STEEL FLATHEAD SCREW	6.000	PC
					VI1950A0	ST. STEEL 4,2X13 TCB SELF-DRILLIN G SCREW	4.000	PC
					VM1170B0	UPPER DOOR FULCRUM CA	1.000	PC
					VM1171B0	DOOR LOWER FULCRUM CA	1.000	PC



COMPONENT			SPARE PART																																																						
Code	Description	Image	Code	Description	Kit components																																																				
VT1272A	CHEFLUX XV393 EXTERNAL BLACK GLASS		KDR1268A	XV393 COMPLETE DOOR	<table border="1"> <thead> <tr> <th>Code</th> <th>Description</th> <th>Qty</th> <th>UOM</th> </tr> </thead> <tbody> <tr> <td>VM1490A0</td> <td>CHEFTOP/BAK ERTOP HANDLE SCREWS COVER</td> <td>2.000</td> <td>PC</td> </tr> <tr> <td>VM1510A0</td> <td>XBC/XVC GROOVED DOOR PIN BUSHING</td> <td>1.000</td> <td>PC</td> </tr> <tr> <td>VM1511A0</td> <td>XBC/XVC SLEEK DOOR PIN BUSHING</td> <td>1.000</td> <td>PC</td> </tr> <tr> <td>VM1591A0</td> <td>GLASS BRACKET INT. XVC1004</td> <td>1.000</td> <td>PC</td> </tr> <tr> <td>VM1630A1</td> <td>INTERNAL GLASS PUSHING CAP</td> <td>2.000</td> <td>PC</td> </tr> <tr> <td>VM1680A0</td> <td>INTERNAL GLASS HINGE</td> <td>2.000</td> <td>PC</td> </tr> <tr> <td>VM1976A0</td> <td>CL BL DOOR COLUMN BLANKING CA</td> <td>2.000</td> <td>PC</td> </tr> <tr> <td>VM2008A0</td> <td>SPACER FOR MICROSWITC</td> <td>1.000</td> <td>PC</td> </tr> <tr> <td>VM2042A0</td> <td>INTERNAL GLASS LATERAL LOCKING SYSTEM</td> <td>2.000</td> <td>PC</td> </tr> <tr> <td>VM2043A0</td> <td>UPPER - LOWER GLASS SUPPORT</td> <td>2.000</td> <td>PC</td> </tr> <tr> <td>VT1095A0</td> <td>XL375/XV393/X VC304-305 INNER GLASS</td> <td>1.000</td> <td>PC</td> </tr> <tr> <td>VT1272A0</td> <td>CHEFLUX XV393 EXTERNAL BLACK GLASS</td> <td>1.000</td> <td>PC</td> </tr> </tbody> </table>	Code	Description	Qty	UOM	VM1490A0	CHEFTOP/BAK ERTOP HANDLE SCREWS COVER	2.000	PC	VM1510A0	XBC/XVC GROOVED DOOR PIN BUSHING	1.000	PC	VM1511A0	XBC/XVC SLEEK DOOR PIN BUSHING	1.000	PC	VM1591A0	GLASS BRACKET INT. XVC1004	1.000	PC	VM1630A1	INTERNAL GLASS PUSHING CAP	2.000	PC	VM1680A0	INTERNAL GLASS HINGE	2.000	PC	VM1976A0	CL BL DOOR COLUMN BLANKING CA	2.000	PC	VM2008A0	SPACER FOR MICROSWITC	1.000	PC	VM2042A0	INTERNAL GLASS LATERAL LOCKING SYSTEM	2.000	PC	VM2043A0	UPPER - LOWER GLASS SUPPORT	2.000	PC	VT1095A0	XL375/XV393/X VC304-305 INNER GLASS	1.000	PC	VT1272A0	CHEFLUX XV393 EXTERNAL BLACK GLASS	1.000	PC
Code	Description	Qty	UOM																																																						
VM1490A0	CHEFTOP/BAK ERTOP HANDLE SCREWS COVER	2.000	PC																																																						
VM1510A0	XBC/XVC GROOVED DOOR PIN BUSHING	1.000	PC																																																						
VM1511A0	XBC/XVC SLEEK DOOR PIN BUSHING	1.000	PC																																																						
VM1591A0	GLASS BRACKET INT. XVC1004	1.000	PC																																																						
VM1630A1	INTERNAL GLASS PUSHING CAP	2.000	PC																																																						
VM1680A0	INTERNAL GLASS HINGE	2.000	PC																																																						
VM1976A0	CL BL DOOR COLUMN BLANKING CA	2.000	PC																																																						
VM2008A0	SPACER FOR MICROSWITC	1.000	PC																																																						
VM2042A0	INTERNAL GLASS LATERAL LOCKING SYSTEM	2.000	PC																																																						
VM2043A0	UPPER - LOWER GLASS SUPPORT	2.000	PC																																																						
VT1095A0	XL375/XV393/X VC304-305 INNER GLASS	1.000	PC																																																						
VT1272A0	CHEFLUX XV393 EXTERNAL BLACK GLASS	1.000	PC																																																						

ASM4102A/0.D02 - General overview - FRONT

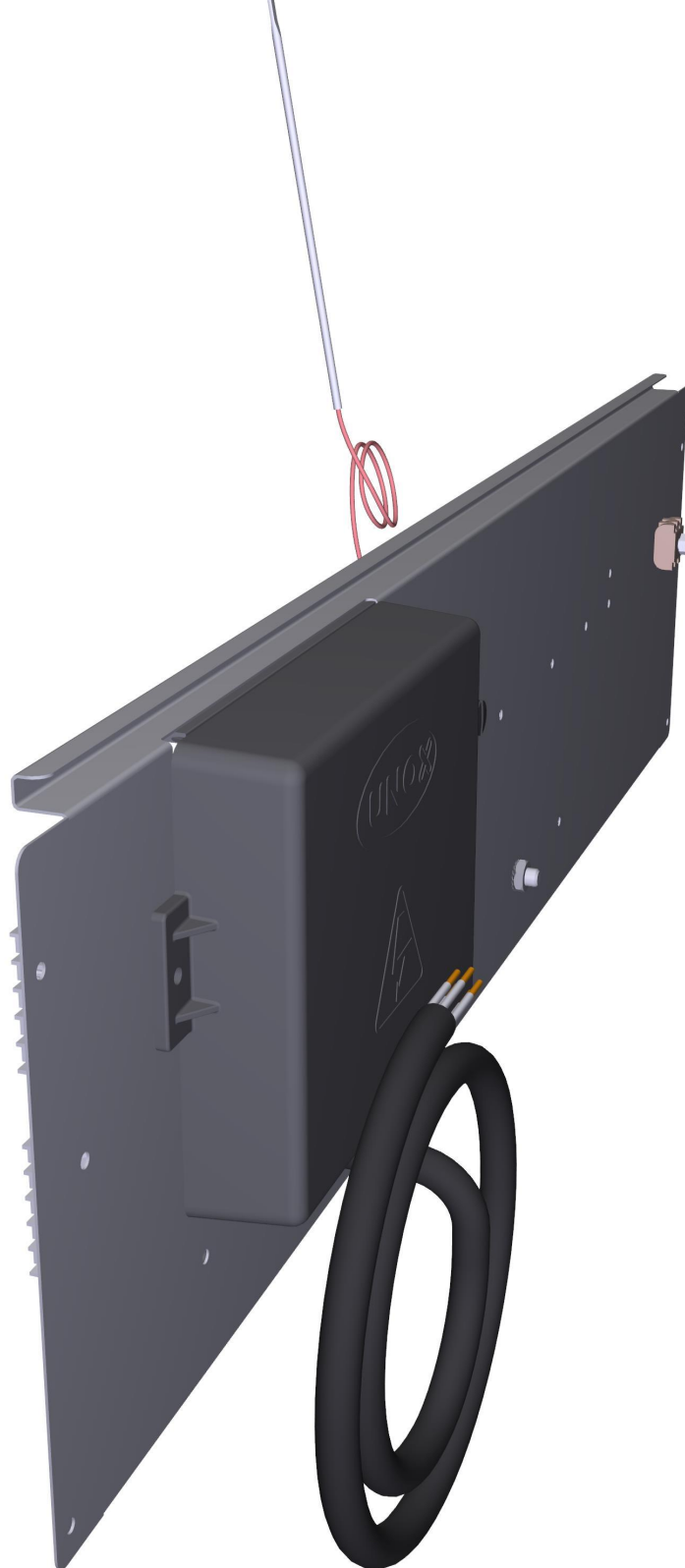





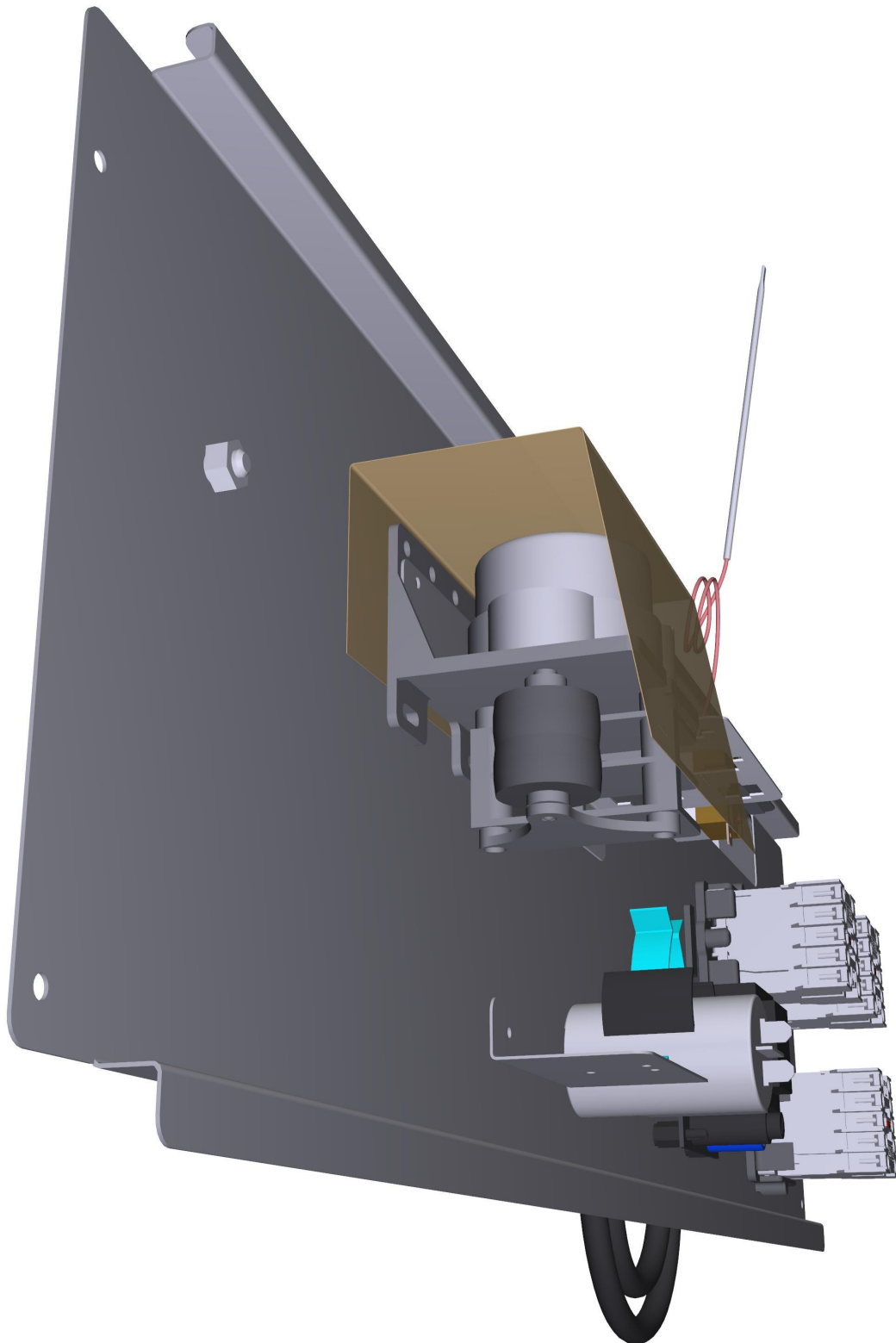

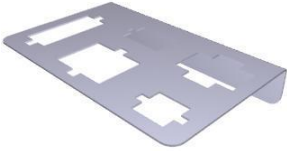

ASM4102A/0.D02 - General overview - REAR

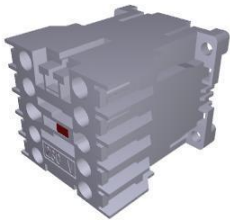





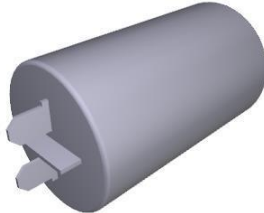
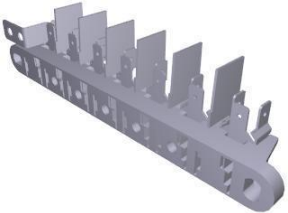

COMPONENT			SPARE PART																		
Code	Description	Image	Code	Description	Kit components																
0H6769B	CONNECTOR FIXING PANEL		0H6769B0	CONNECTOR FIXING PANEL																	
0H7141B	XV393 CHEFLUX COMPONENTS HOLDER		0H7141B1	XV393 CHEFLUX COMPONENTS HOLDER																	
VE1615A	MOTOR REVERSING SWITCH		KVE1615A	MOTOR REVERSING SWITCH KIT	<table border="1"> <thead> <tr> <th>Code</th> <th>Description</th> <th>Qty</th> <th>UOM</th> </tr> </thead> <tbody> <tr> <td>0H1429A0</td> <td>VE1615A INVERTER FIXING PLATE</td> <td>1.000</td> <td>PC</td> </tr> <tr> <td>VE1615A0</td> <td>MOTOR REVERSING SWITCH</td> <td>1.000</td> <td>PC</td> </tr> <tr> <td>VI1960A2</td> <td></td> <td>3.000</td> <td>PC</td> </tr> </tbody> </table>	Code	Description	Qty	UOM	0H1429A0	VE1615A INVERTER FIXING PLATE	1.000	PC	VE1615A0	MOTOR REVERSING SWITCH	1.000	PC	VI1960A2		3.000	PC
Code	Description	Qty	UOM																		
0H1429A0	VE1615A INVERTER FIXING PLATE	1.000	PC																		
VE1615A0	MOTOR REVERSING SWITCH	1.000	PC																		
VI1960A2		3.000	PC																		
VE1115A	20 A 230V 4 POLES MINICONTACTOR		KVE1115A	20A 230V 4 POLES MINICONTACTOR KI	<table border="1"> <thead> <tr> <th>Code</th> <th>Description</th> <th>Qty</th> <th>UOM</th> </tr> </thead> <tbody> <tr> <td>VE1115A0</td> <td>20 A 230V 4 POLES MINICONTACT OR</td> <td>1.000</td> <td>PC</td> </tr> <tr> <td>VM1075A1</td> <td>PLASTIC CLIP TO FIX CONTACTORS</td> <td>4.000</td> <td>PC</td> </tr> </tbody> </table>	Code	Description	Qty	UOM	VE1115A0	20 A 230V 4 POLES MINICONTACT OR	1.000	PC	VM1075A1	PLASTIC CLIP TO FIX CONTACTORS	4.000	PC				
Code	Description	Qty	UOM																		
VE1115A0	20 A 230V 4 POLES MINICONTACT OR	1.000	PC																		
VM1075A1	PLASTIC CLIP TO FIX CONTACTORS	4.000	PC																		
VM1056A	SMALL CONTACTOR BRACKET VE1115A		VM1056A0	SMALL CONTACTOR BRACKET VE1115A																	

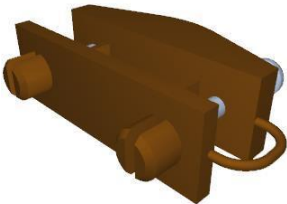

COMPONENT			SPARE PART																										
Code	Description	Image	Code	Description	Kit components																								
CE1355A	CABLE 5 X 2,5 MMQ H07RNF L = 1,5 MT		KCE1355A	L=1.5M 5x2.5mmq POWER CABLE KIT	<table border="1"> <thead> <tr> <th>Code</th> <th>Description</th> <th>Qty</th> <th>UOM</th> </tr> </thead> <tbody> <tr> <td>CE1355A1</td> <td>CABLE 5 X 2,5 MMQ H07RNF L = 1,5 MT</td> <td>1.000</td> <td>PC</td> </tr> </tbody> </table>	Code	Description	Qty	UOM	CE1355A1	CABLE 5 X 2,5 MMQ H07RNF L = 1,5 MT	1.000	PC																
Code	Description	Qty	UOM																										
CE1355A1	CABLE 5 X 2,5 MMQ H07RNF L = 1,5 MT	1.000	PC																										
CN1003A	6,3 Uf MOTOR CAPACITOR		KCN1003A	6,3 uF MOTOR CAPACITOR KIT	<table border="1"> <thead> <tr> <th>Code</th> <th>Description</th> <th>Qty</th> <th>UOM</th> </tr> </thead> <tbody> <tr> <td>CN1003A0</td> <td>6,3 Uf MOTOR CAPACITOR</td> <td>1.000</td> <td>PC</td> </tr> <tr> <td>VI1931A0</td> <td>M8x1.65 H4 CH13 ZINC PLATED NUT</td> <td>1.000</td> <td>PC</td> </tr> <tr> <td>VI1932A0</td> <td>D8 INDENTED ZINC PLATED WASHER</td> <td>1.000</td> <td>PC</td> </tr> </tbody> </table>	Code	Description	Qty	UOM	CN1003A0	6,3 Uf MOTOR CAPACITOR	1.000	PC	VI1931A0	M8x1.65 H4 CH13 ZINC PLATED NUT	1.000	PC	VI1932A0	D8 INDENTED ZINC PLATED WASHER	1.000	PC								
Code	Description	Qty	UOM																										
CN1003A0	6,3 Uf MOTOR CAPACITOR	1.000	PC																										
VI1931A0	M8x1.65 H4 CH13 ZINC PLATED NUT	1.000	PC																										
VI1932A0	D8 INDENTED ZINC PLATED WASHER	1.000	PC																										
MR1004A	41A 450V 7 POLES TERMINAL		KMR1004A	FTW 1+2+3/4+5+6 TERMINAL BLOCK KIT	<table border="1"> <thead> <tr> <th>Code</th> <th>Description</th> <th>Qty</th> <th>UOM</th> </tr> </thead> <tbody> <tr> <td>MR1004A1</td> <td>41A 450V 7 POLES TERMINAL</td> <td>1.000</td> <td>PC</td> </tr> </tbody> </table>	Code	Description	Qty	UOM	MR1004A1	41A 450V 7 POLES TERMINAL	1.000	PC																
Code	Description	Qty	UOM																										
MR1004A1	41A 450V 7 POLES TERMINAL	1.000	PC																										
PE1782A	200-240Vac 12Vcc 6VA POWER SUPPL		KPE1782A	LED BAR 200-240Vac 12Vcc TRANSFORMER KIT	<table border="1"> <thead> <tr> <th>Code</th> <th>Description</th> <th>Qty</th> <th>UOM</th> </tr> </thead> <tbody> <tr> <td>PE1782A0</td> <td>200-240Vac 12Vcc 6VA POWER SUPPLY</td> <td>1.000</td> <td>PC</td> </tr> <tr> <td>VM1447A0</td> <td></td> <td>0.500</td> <td>PC</td> </tr> <tr> <td>VM1745A0</td> <td>CARD SUPPORT</td> <td>4.000</td> <td>PC</td> </tr> </tbody> </table>	Code	Description	Qty	UOM	PE1782A0	200-240Vac 12Vcc 6VA POWER SUPPLY	1.000	PC	VM1447A0		0.500	PC	VM1745A0	CARD SUPPORT	4.000	PC								
Code	Description	Qty	UOM																										
PE1782A0	200-240Vac 12Vcc 6VA POWER SUPPLY	1.000	PC																										
VM1447A0		0.500	PC																										
VM1745A0	CARD SUPPORT	4.000	PC																										
TR1136A	318°C -0/+24 1 POLE SAFETY THERMOSTAT		KTR1136A	318°C -0/+24 SAFETY THERMOSTAT KIT	<table border="1"> <thead> <tr> <th>Code</th> <th>Description</th> <th>Qty</th> <th>UOM</th> </tr> </thead> <tbody> <tr> <td>0H8120A0</td> <td>XEVL BULB PASS-THROU GH COVER</td> <td>1.000</td> <td>PC</td> </tr> <tr> <td>GN1531A0</td> <td>THERMOSTAT BULB INLET SEALING</td> <td>1.000</td> <td>PC</td> </tr> <tr> <td>SL1045A0</td> <td>S57 BLACK SILICONE - 80ml CARTRIDGE</td> <td>1.000</td> <td>PC</td> </tr> <tr> <td>TR1136A0</td> <td>318°C -0/+24 1 POLE SAFETY THERMOSTAT</td> <td>1.000</td> <td>PC</td> </tr> <tr> <td>VI1220A1</td> <td>4,2x12 TCB SELF-TAPPIN G SCREW</td> <td>3.000</td> <td>PC</td> </tr> </tbody> </table>	Code	Description	Qty	UOM	0H8120A0	XEVL BULB PASS-THROU GH COVER	1.000	PC	GN1531A0	THERMOSTAT BULB INLET SEALING	1.000	PC	SL1045A0	S57 BLACK SILICONE - 80ml CARTRIDGE	1.000	PC	TR1136A0	318°C -0/+24 1 POLE SAFETY THERMOSTAT	1.000	PC	VI1220A1	4,2x12 TCB SELF-TAPPIN G SCREW	3.000	PC
Code	Description	Qty	UOM																										
0H8120A0	XEVL BULB PASS-THROU GH COVER	1.000	PC																										
GN1531A0	THERMOSTAT BULB INLET SEALING	1.000	PC																										
SL1045A0	S57 BLACK SILICONE - 80ml CARTRIDGE	1.000	PC																										
TR1136A0	318°C -0/+24 1 POLE SAFETY THERMOSTAT	1.000	PC																										
VI1220A1	4,2x12 TCB SELF-TAPPIN G SCREW	3.000	PC																										

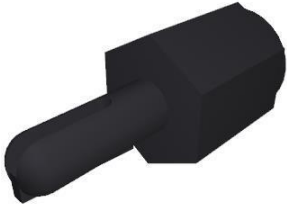

COMPONENT			SPARE PART														
Code	Description	Image	Code	Description	Kit components												
VE1075A	STRAIN RELIEF PA6 UL94V2+ FIXING SCREWS		KVE1075A	PANEL WIRE CLAMP 10PCS KIT	<table border="1"> <thead> <tr> <th>Code</th> <th>Description</th> <th>Qty</th> <th>UOM</th> </tr> </thead> <tbody> <tr> <td>VE1075A0</td> <td>STRAIN RELIEF PA6 UL94V2+ FIXING SCREWS</td> <td>10.000</td> <td>PC</td> </tr> </tbody> </table>	Code	Description	Qty	UOM	VE1075A0	STRAIN RELIEF PA6 UL94V2+ FIXING SCREWS	10.000	PC				
Code	Description	Qty	UOM														
VE1075A0	STRAIN RELIEF PA6 UL94V2+ FIXING SCREWS	10.000	PC														
VM1310A	COVER FOR XB/XV/XVC/XG TERMINAL BLOCK		VM1310A0	COVER FOR XB/XV/XVC/XG TERMINAL BLOCK													
VM1745A	CARD SUPPORT		KVM1745A	BOARD SUPPORT 10 PCS KIT	<table border="1"> <thead> <tr> <th>Code</th> <th>Description</th> <th>Qty</th> <th>UOM</th> </tr> </thead> <tbody> <tr> <td>VM1745A0</td> <td>CARD SUPPORT</td> <td>10.000</td> <td>PC</td> </tr> </tbody> </table>	Code	Description	Qty	UOM	VM1745A0	CARD SUPPORT	10.000	PC				
Code	Description	Qty	UOM														
VM1745A0	CARD SUPPORT	10.000	PC														
VM1750A	BRASS COMB CLAM		KVM1750A	COMB TERMINAL BLOCK KIT	<table border="1"> <thead> <tr> <th>Code</th> <th>Description</th> <th>Qty</th> <th>UOM</th> </tr> </thead> <tbody> <tr> <td>VI1040A0</td> <td>INDENTED INTERNAL WASHER D=6 ZN</td> <td>2.000</td> <td>PC</td> </tr> <tr> <td>VM1750A0</td> <td>BRASS COMB CLAMP</td> <td>1.000</td> <td>PC</td> </tr> </tbody> </table>	Code	Description	Qty	UOM	VI1040A0	INDENTED INTERNAL WASHER D=6 ZN	2.000	PC	VM1750A0	BRASS COMB CLAMP	1.000	PC
Code	Description	Qty	UOM														
VI1040A0	INDENTED INTERNAL WASHER D=6 ZN	2.000	PC														
VM1750A0	BRASS COMB CLAMP	1.000	PC														